

**INSTALLATION, OPERATION,
AND MAINTENANCE MANUAL**
WITH PARTS LIST



10 SERIES PUMP

MODEL
112D60-B Including /WW

THE GORMAN-RUPP COMPANY • MANSFIELD, OHIO

www.grpumps.com

GORMAN-RUPP OF CANADA LIMITED • ST. THOMAS, ONTARIO, CANADA Printed in U.S.A.

©2004 The Gorman-Rupp Company

Register your new
Gorman-Rupp pump online at
www.grpumps.com/register.

Valid serial number and e-mail address required.

RECORD YOUR PUMP MODEL AND SERIAL NUMBER

Please record your pump model and serial number in the spaces provided below. Your Gorman-Rupp distributor needs this information when you require parts or service.

Pump Model: _____

Serial Number: _____

TABLE OF CONTENTS

INTRODUCTION	PAGE I – 1
SAFETY - SECTION A	PAGE A – 1
INSTALLATION – SECTION B	PAGE B – 1
PREINSTALLATION INSPECTION	PAGE B – 1
POSITIONING PUMP	PAGE B – 2
Lifting	PAGE B – 2
Mounting	PAGE B – 2
SUCTION AND DISCHARGE PIPING	PAGE B – 2
Materials	PAGE B – 2
Line Configuration	PAGE B – 2
Connections to Pump	PAGE B – 2
Gauges	PAGE B – 3
SUCTION LINES	PAGE B – 3
Fittings	PAGE B – 3
Strainers	PAGE B – 3
Sealing	PAGE B – 3
Suction Lines In Sumps	PAGE B – 3
Suction Line Positioning	PAGE B – 4
DISCHARGE LINES	PAGE B – 4
Siphoning	PAGE B – 4
Valves	PAGE B – 4
Bypass Lines	PAGE B – 5
AUTOMATIC AIR RELEASE VALVE	PAGE B – 6
Theory of Operation	PAGE B – 6
Air Release Valve Installation	PAGE B – 6
ALIGNMENT	PAGE B – 7
Coupled Drives	PAGE B – 8
V-Belt Drives	PAGE B – 8
V-BELT TENSIONING	PAGE B – 9
General Rules of Tensioning	PAGE B – 9
Tension Measurement	PAGE B – 9
OPERATION – SECTION C	PAGE C – 1
PRIMING	PAGE C – 1
STARTING	PAGE C – 1
Rotation	PAGE C – 1
OPERATION	PAGE C – 2
Lines With a Bypass	PAGE C – 2
Lines Without a Bypass	PAGE C – 2
Leakage	PAGE C – 2
Liquid Temperature And Overheating	PAGE C – 2
Strainer Check	PAGE C – 2
Pump Vacuum Check	PAGE C – 3
STOPPING	PAGE C – 3
Cold Weather Preservation	PAGE C – 3
BEARING TEMPERATURE CHECK	PAGE C – 3

TABLE OF CONTENTS
(continued)

TROUBLESHOOTING – SECTION D	PAGE D – 1
PREVENTIVE MAINTENANCE	PAGE D – 3
PUMP MAINTENANCE AND REPAIR - SECTION E	PAGE E – 1
STANDARD PERFORMANCE CURVE	PAGE E – 1
PARTS LIST:	
Pump Model	PAGE E – 3
PUMP AND SEAL DISASSEMBLY AND REASSEMBLY	PAGE E – 4
Suction Check Valve Removal and Disassembly	PAGE E – 4
Wear Plate And Suction Elbow Removal	PAGE E – 4
Impeller Removal	PAGE E – 5
Seal Removal and Disassembly	PAGE E – 5
Pump Disassembly	PAGE E – 5
Shaft and Bearing Removal and Disassembly	PAGE E – 6
Shaft and Bearing Reassembly and Installation	PAGE E – 7
Seal Reassembly and Installation	PAGE E – 8
Impeller Installation And Adjustment	PAGE E – 9
Pump Casing Installation	PAGE E – 10
Wear Plate And Suction Elbow Installation	PAGE E – 10
Suction Check Valve Installation	PAGE E – 10
Final Pump Assembly	PAGE E – 11
PRESSURE RELIEF VALVE MAINTENANCE	PAGE E – 11
LUBRICATION	PAGE E – 11
Bearings	PAGE E – 11
Seal Assembly	PAGE E – 11
Power Source	PAGE E – 11

INTRODUCTION

Thank You for purchasing a Gorman-Rupp pump. **Read this manual** carefully to learn how to safely install and operate your pump. Failure to do so could result in personal injury or damage to the pump.

This pump is a 10 Series, enclosed impeller, self-priming centrifugal model with a suction check valve. The pump is designed for handling wastewater, mud and slurries containing specified entrained solids. The basic material of construction for wetted parts is gray iron, with a ductile iron wear plate and an alloy steel impeller shaft.

This manual will alert personnel to known procedures which require special attention, to those which could damage equipment, and to those which could be dangerous to personnel. However, this manual cannot possibly anticipate and provide detailed precautions for every situation that might occur during maintenance of the unit. Therefore, it is the responsibility of the owner/maintenance personnel to ensure that **only** safe, established maintenance procedures are used, and that any procedures not addressed in this manual are performed **only** after establishing that neither personal safety nor pump integrity are compromised by such practices.

For information or technical assistance on the power source, contact the power source manufacturer's local dealer or representative.

If there are any questions regarding the pump or its application which are not covered in this manual or in other literature accompanying this unit, please contact your Gorman-Rupp distributor, or:

The Gorman-Rupp Company
P.O. Box 1217
Mansfield, Ohio 44901-1217
Phone: (419) 755-1011
 or:
Gorman-Rupp of Canada Limited
70 Burwell Road
St. Thomas, Ontario N5P 3R7
Phone: (519) 631-2870

The following are used to alert maintenance personnel to procedures which require special attention, to those which could damage equipment, and to those which could be dangerous to personnel:



Immediate hazards which WILL result in severe personal injury or death. These instructions describe the procedure required and the injury which will result from failure to follow the procedure.



Hazards or unsafe practices which COULD result in severe personal injury or death. These instructions describe the procedure required and the injury which could result from failure to follow the procedure.



Hazards or unsafe practices which COULD result in minor personal injury or product or property damage. These instructions describe the requirements and the possible damage which could result from failure to follow the procedure.

NOTE

Instructions to aid in installation, operation, and maintenance or which clarify a procedure.

SAFETY - SECTION A

This information applies to 10 Series basic pumps. Gorman-Rupp has no control over or particular knowledge of the power source which will be used. Refer to the manual accompanying the power source before attempting to begin operation.

Because pump installations are seldom identical, this manual cannot possibly provide detailed instructions and precautions for each specific application. Therefore, it is the owner/installer's responsibility to ensure that applications not addressed in this manual are performed only after establishing that neither operator safety nor pump integrity are compromised by the installation.



Before attempting to open or service the pump:

1. Familiarize yourself with this manual.
2. Disconnect or lock out the power source to ensure that the pump will remain inoperative.
3. Allow the pump to completely cool if overheated.
4. Check the temperature before opening any covers, plates, or plugs.
5. Close the suction and discharge valves.
6. Vent the pump slowly and cautiously.
7. Drain the pump.



This pump is designed to handle wastewater, mud and slurries containing spe-

cified entrained solids. Do not attempt to pump volatile, corrosive or flammable liquids which may damage the pump or endanger personnel as a result of pump failure.



Use lifting and moving equipment in good repair and with adequate capacity to prevent injuries to personnel or damage to equipment. Suction and discharge hoses and piping must be removed from the pump before lifting.



After the pump has been positioned, make certain that the pump and all piping or hose connections are tight, properly supported and secure before operation.



Do not operate the pump against a closed discharge valve for long periods of time. If operated against a closed discharge valve, pump components will deteriorate, and the liquid could come to a boil, build pressure, and cause the pump casing to rupture or explode.



Do not remove plates, covers, gauges, pipe plugs, or fittings from an overheated pump. Vapor pressure within the pump can cause parts being disengaged to be ejected with great force. Allow the pump to cool before servicing.



Do not operate the pump without shields and/or guards in place over the drive shafts, belts, and/or couplings, or other rotating parts. Exposed rotating parts can catch clothing, fingers, or tools, causing severe injury to personnel.

INSTALLATION – SECTION B

Review all SAFETY information in Section A.

Since pump installations are seldom identical, this section offers only general recommendations and practices required to inspect, position, and arrange the pump and piping.

Most of the information pertains to a standard **static lift** application where the pump is positioned above the free level of liquid to be pumped.

If installed in a **flooded suction application** where the liquid is supplied to the pump under pressure, some of the information such as mounting, line configuration, and priming must be tailored to the

specific application. Since the pressure supplied to the pump is critical to performance and safety, **be sure** to limit the incoming pressure to 50% of the maximum permissible operating pressure as shown on the pump performance curve (see Section E, Page 1).

For further assistance, contact your Gorman-Rupp distributor or the Gorman-Rupp Company.

Pump Dimensions

See Figure B-1 for the approximate physical dimensions of this pump.

OUTLINE DRAWING

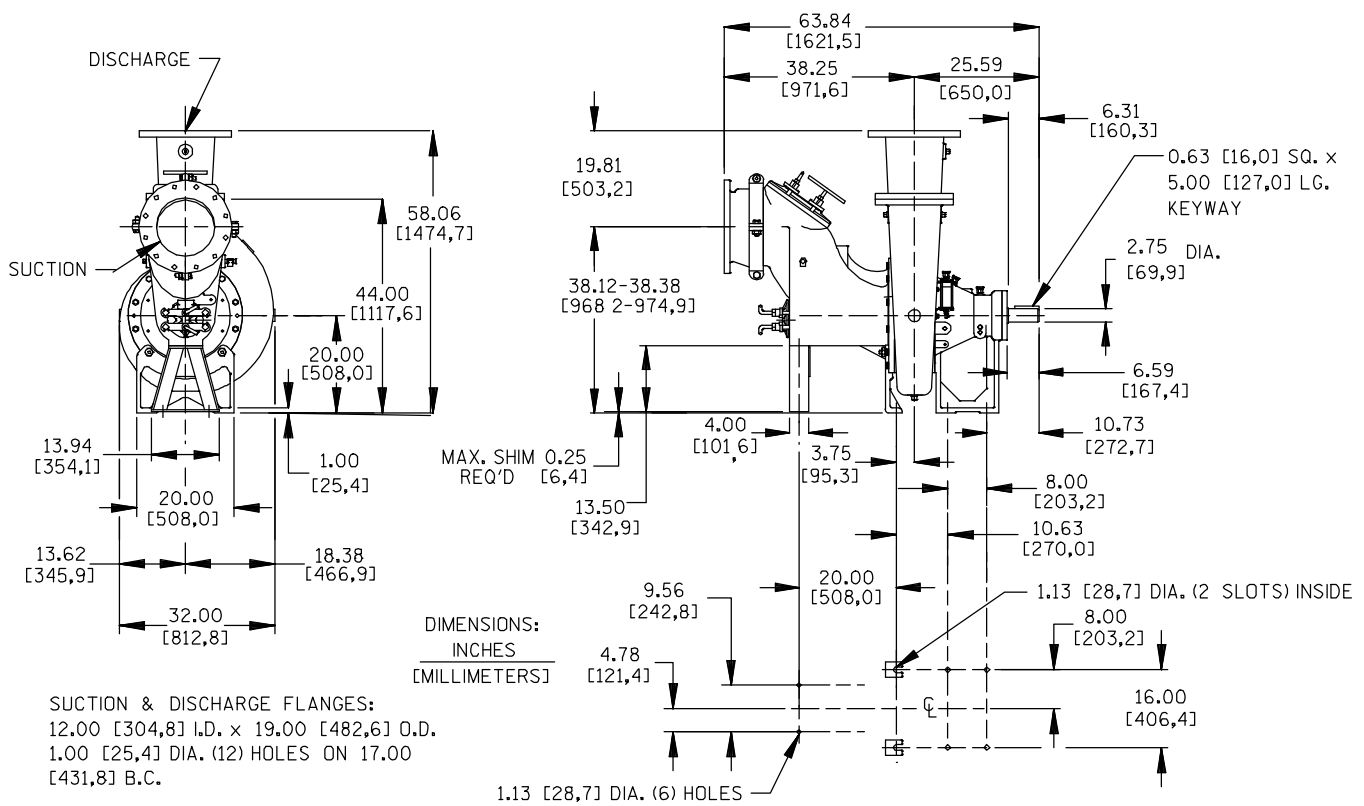

Figure B-1. Pump Model 112D60-B

PREINSTALLATION INSPECTION

The pump assembly was inspected and tested before shipment from the factory. Before installation, inspect the pump for damage which may have occurred during shipment. Check as follows:

- a. Inspect the pump for cracks, dents, damaged threads, and other obvious damage.
- b. Check for and tighten loose attaching hardware. Since gaskets tend to shrink after dry-

ing, check for loose hardware at mating surfaces.

- c. Carefully read all tags, decals, and markings on the pump assembly, and perform all duties indicated. Note that the pump shaft rotates in the required direction.



Only operate this pump in the direction indicated by the arrow on the pump body and on the accompanying decal. Otherwise, the impeller could become loosened from the shaft and seriously damage the pump.

- d. Check levels and lubricate as necessary. Refer to **LUBRICATION** in the **MAINTENANCE AND REPAIR** section of this manual and perform duties as instructed.
- e. If the pump has been stored for more than 12 months, some of the components or lubricants may have exceeded their maximum shelf life. These **must be inspected or replaced** to ensure maximum pump service.

If the maximum shelf life has been exceeded, or if anything appears to be abnormal, contact your Gorman-Rupp distributor or the factory to determine the repair or updating policy. **Do not** put the pump into service until appropriate action has been taken.

POSITIONING PUMP

Lifting

Pump unit weights will vary depending on the mounting and drive provided. Check the shipping tag on the unit packaging for the actual weight, and use lifting equipment with appropriate capacity. Drain the pump and remove all customer-installed equipment such as suction and discharge hoses or piping before attempting to lift existing, installed units.



The pump assembly can be seriously damaged if the chains or cables used to lift and move the unit are improperly wrapped around the pump.

Mounting

Locate the pump in an accessible place as close as practical to the liquid being pumped. Level mounting is essential for proper operation.

The pump may have to be supported or shimmed to provide for level operation or to eliminate vibration.

SUCTION AND DISCHARGE PIPING

Pump performance is adversely effected by increased suction lift, discharge elevation, and friction losses. See the performance curve on Page E-1 to be sure your overall application allows pump to operate within the safe operation range.

Materials

Either pipe or hose maybe used for suction and discharge lines; however, the materials must be compatible with the liquid being pumped. If hose is used in suction lines, it must be the rigid-wall, reinforced type to prevent collapse under suction. Using piping couplings in suction lines is not recommended.

Line Configuration

Keep suction and discharge lines as straight as possible to minimize friction losses. Make minimum use of elbows and fittings, which substantially increase friction loss. If elbows are necessary, use the long-radius type to minimize friction loss.

Connections to Pump

Before tightening a connecting flange, align it exactly with the pump port. Never pull a pipe line into place by tightening the flange bolts and/or couplings.

Lines near the pump must be independently supported to avoid strain on the pump which could

cause excessive vibration, decreased bearing life, and increased shaft and seal wear. If hose-type lines are used, they should have adequate support to secure them when filled with liquid and under pressure.

Gauges

Most pumps are drilled and tapped for installing discharge pressure and vacuum suction gauges. If these gauges are desired for pumps that are not tapped, drill and tap the suction and discharge lines not less than 18 inches (457,2 mm) from the suction and discharge ports and install the lines. Installation closer to the pump may result in erratic readings.

SUCTION LINES

To avoid air pockets which could affect pump priming, the suction line must be as short and direct as possible. When operation involves a suction lift, the line must always slope upward to the pump from the source of the liquid being pumped; if the line slopes down to the pump at any point along the suction run, air pockets will be created.

Never use a suction line smaller than the pump inlet connection. This pump is designed to accept a standard 12 inch pipe flange.

If a horizontal suction line must be used, the **maximum** acceptable length is 6 feet. The preferred installation would angle the suction line down to the source of the liquid at a 45° angle.



Use of long horizontal suction lines increase partial prime operation time which results in erratic performance and reduced pump life.

The **maximum** vertical suction lift for this pump is 15 feet. The pump is not designed to prime or operate at a higher lift.

Fittings

Suction lines should be the same size as the pump inlet. If reducers are used in suction lines, they

should be the eccentric type, and should be installed with the flat part of the reducers uppermost to avoid creating air pockets. Valves are not normally used in suction lines, but if a valve is used, install it with the stem horizontal to avoid air pockets.

Strainers

A strainer or other device should be used to filter solids larger than the pump's capacity to avoid damage or decreased performance. Information about solids size handling can be found on the performance curve for your specific pump. When selecting or installing a strainer, make certain that the total area of the openings in the strainer is at least three or four times the cross section of the suction line, and the openings will not permit passage of solids larger than the solids handling capability of the pump.

Sealing

Since even a slight leak will affect priming, head, and capacity, especially when operating with a high suction lift, all connections in the suction line should be sealed with pipe dope to ensure an airtight seal. Follow the sealant manufacturer's recommendations when selecting and applying the pipe dope. The pipe dope should be compatible with the liquid being pumped.

Suction Lines In Sumps

If a single suction line is installed in a sump, it should be positioned away from the wall of the sump at a distance equal to 1–1/2 times the diameter of the suction line.

If there is a liquid flow from an open pipe into the sump, the flow should be kept away from the suction inlet because the inflow will carry air down into the sump, and air entering the suction line will reduce pump efficiency.

If it is necessary to position inflow close to the suction inlet, install a baffle between the inflow and the suction inlet at a distance 1–1/2 times the diameter of the suction pipe. The baffle will allow en-

trained air to escape from the liquid before it is drawn into the suction inlet.

If two suction lines are installed in a single sump, the flow paths may interact, reducing the efficiency of one or both pumps. To avoid this, position the suction inlets so that they are separated by a distance equal to at least 3 times the diameter of the suction pipe.

Suction Line Positioning

The depth of submergence of the suction line is critical to efficient pump operation. Figure B-2

shows recommended minimum submergence vs. velocity.

NOTE

The pipe submergence required may be reduced by installing a standard pipe increaser fitting at the end of the suction line. The larger opening size will reduce the inlet velocity. Calculate the required submergence using the following formula based on the increased opening size (area or diameter).

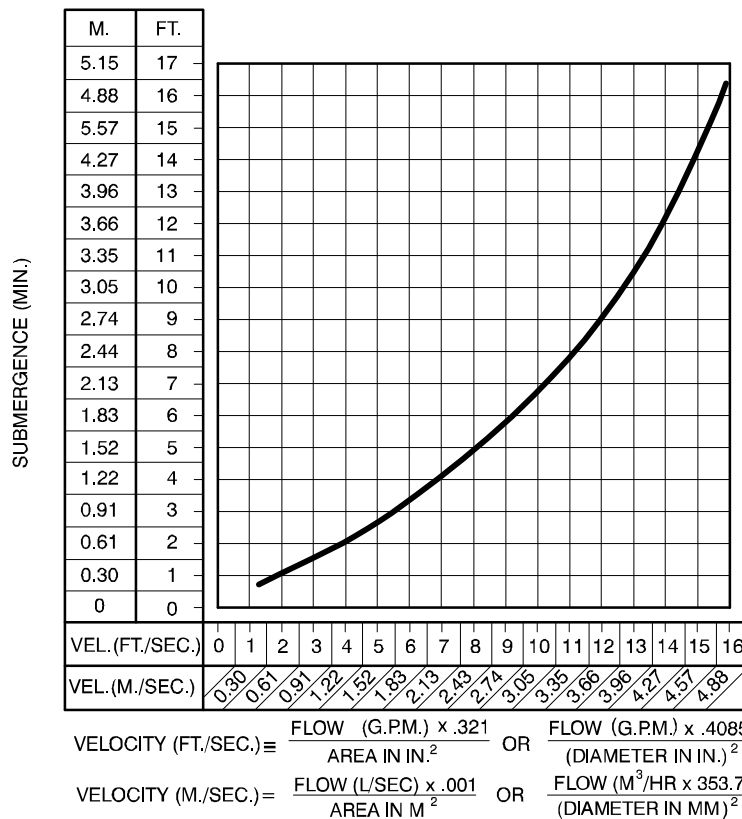

Figure B-2. Recommended Minimum Suction Line Submergence vs. Velocity

DISCHARGE LINES

Siphoning

Do not terminate the discharge line at a level lower than that of the liquid being pumped unless a siphon breaker is used in the line. Otherwise, a siphoning action causing damage to the pump could result.

Valves

If a throttling valve is desired in the discharge line, use a valve as large as the largest pipe to minimize friction losses. Never install a throttling valve in a suction line.

A check valve in the discharge line is normally recommended, but it is not necessary in low discharge head applications.

With high discharge heads, it is recommended that a throttling valve and a system check valve be installed in the discharge line to protect the pump from excessive shock pressure and reverse rotation when it is stopped.

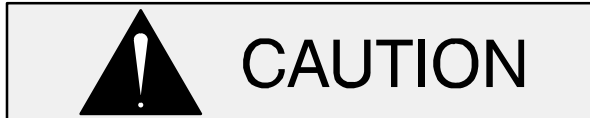

If the application involves a high discharge head, gradually close the discharge throttling valve before stopping the pump.

Bypass Lines

Self-priming pumps are not air compressors. During the priming cycle, air from the suction line must be vented to atmosphere on the discharge side. If the discharge line is open, this air will be vented through the discharge. However, if a check valve has been installed in the discharge line, the discharge side of the pump must be opened to atmospheric pressure through a bypass line installed between the pump discharge and the check valve. A self-priming centrifugal pump **will not prime** if there is sufficient static liquid head to hold the discharge check valve closed.

NOTE

The bypass line should be sized so that it does not affect pump discharge capacity; however, the bypass line should be at least 1 inch (25,4 mm) in diameter to minimize the chance of plugging.

In **low discharge head applications** (less than 30 feet (9,1 m)), it is recommended that the bypass line be run back to the wet well, and located 6 inches below the water level or cut-off point of the low level pump. In some installations, this bypass outline may be terminated with a six-to-eight foot (1,8 to 2,4 m) length of 1-1/4 inch (31,8 mm) I.D. **smooth-bore** hose; air and liquid vented during the priming process will then agitate the hose and break up any solids, grease, or other substances likely to cause clogging.



A bypass line that is returned to a wet well must be secured against being drawn into the pump suction inlet.

It is also recommended that pipe unions be installed at each 90° elbow in a bypass line to ease disassembly and maintenance.

In **high discharge head applications** (more than 30 feet (9,1 m)), an excessive amount of liquid may be bypassed and forced back to the wet well under the full working pressure of the pump; this will reduce overall pumping efficiency. **Therefore, it is recommended that a Gorman-Rupp Automatic Air Release Valve be installed in the bypass line.**

Gorman-Rupp Automatic Air Release Valves are reliable, and require minimum maintenance. Consult your Gorman-Rupp distributor, or contact the Gorman-Rupp Company for selection of an Automatic Air Release Valve to fit your application.



Except in certain specific applications (to prevent flooding during service of an automatic air release valve in a below-ground lift station), if a manual shut-off valve is installed **anywhere** in a bypass line, it **must** be a full-opening, **ball-type** valve to prevent plugging by solids.



A manual shut-off valve should not be installed in any bypass line. A manual shut-off valve may inadvertently be left closed during operation. A pump which has lost prime may continue to operate without reaching prime, causing dangerous overheating and possible explosive rupture of the pump casing. Personnel could be severely injured.

Allow an over-heated pump to completely cool before servicing. Do not re-

move plates, covers, gauges, or fittings from an over-heated pump. Liquid within the pump can reach boiling temperatures, and vapor pressure within the pump can cause parts being disengaged to be ejected with great force. After the pump completely cools, drain the liquid from the pump by removing the casing drain plug. Use caution when removing the plug to prevent injury to personnel from hot liquid.

AUTOMATIC AIR RELEASE VALVE

When properly installed, a Gorman-Rupp Automatic Air Release Valve will permit air to escape through the bypass line and then close automatically when the pump is fully primed and pumping at full capacity.



Some leakage (1 to 5 gallons [3.8 to 19 liters] per minute) will occur when the valve is fully closed. Be sure the bypass line is directed back to the wet well or tank to prevent hazardous spills.

Consult the manual accompanying the Air Release Valve for additional information on valve installation and performance.

ALIGNMENT

The alignment of the pump and its power source is critical for trouble-free mechanical operation. In either a flexible coupling or V-belt driven system, the driver and pump must be mounted so that their shafts are aligned with and parallel to each other. It is imperative that alignment be checked after the pump and piping are installed, and before operation.

NOTE

Check **Rotation**, Section C, before final alignment of the pump.

When mounted at the Gorman-Rupp factory, driver and pump are aligned before shipment. Misalignment will occur in transit and handling. Pumps **must** be checked and realigned before operation. Before checking alignment, tighten the foundation bolts. The pump casing feet and/or pedestal feet, and the driver mounting bolts should also be tightly secured.



When checking alignment, disconnect the power source to ensure that the pump will remain inoperative.



Adjusting the alignment in one direction may alter the alignment in another direction. Check each procedure after altering alignment.

Coupled Drives

When using couplings, the axis of the power source must be aligned to the axis of the pump shaft in both the horizontal and vertical planes. Most couplings require a specific gap or clearance between the driving and the driven shafts. Refer to the coupling manufacturer's service literature.

Align spider insert type couplings by using calipers to measure the dimensions on the circumference of the outer ends of the coupling hub every 90°. The coupling is in alignment when the hub ends are the same distance apart at all points (see Figure B-3).

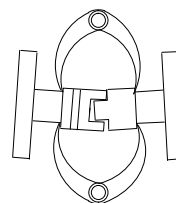

Figure B-3. Aligning Spider-Type Couplings

Align non-spider type couplings by using a feeler gauge or taper gauge between the coupling halves

every 90°. The coupling is in alignment when the hubs are the same distance apart at all points (see Figure B—4).

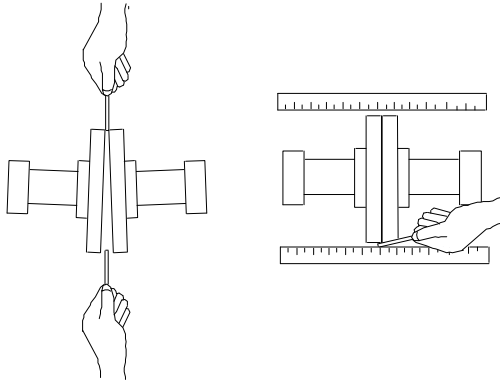

Figure B—4. Aligning Non-Spider-Type Couplings

Check parallel adjustment by laying a straightedge across both coupling rims at the top, bottom, and side. When the straightedge rests evenly on both halves of the coupling, the coupling is in horizontal parallel alignment. If the coupling is misaligned, use a feeler gauge between the coupling and the straightedge to measure the amount of misalignment.

Belt Drives

When using belt drives, the power source and the pump must be parallel. Use a straightedge along the sides of the pulleys to ensure that the pulleys are properly aligned (see Figure B—5). In drive systems using two or more belts, make certain that the belts are a matched set; unmatched sets will cause accelerated belt wear.

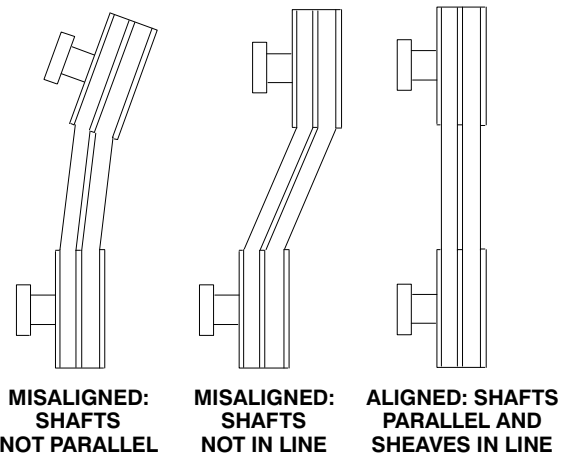

Figure B—5. Alignment of V-Belt Driven Pumps

Tighten the belts in accordance with the belt manufacturer's instructions. If the belts are too loose, they will slip; if the belts are too tight, there will be excessive power loss and possible bearing failure. Select pulleys that will match the proper speed ratio; overspeeding the pump may damage both pump and power source.



Do not operate the pump without the guard in place over the rotating parts. Exposed rotating parts can catch clothing, fingers, or tools, causing severe injury to personnel.

V-BELT TENSIONING

General Rules of Tensioning

For new V-belts, check the tension after 5, 20 and 50 hours of operation and re-tension as required (see the following procedure for measuring belt tension). Thereafter, check and re-tension if required monthly or at 500 hour intervals, whichever comes first.

Ideal V-belt tension is the **lowest** tension at which the belt will not slip under peak load conditions. Do not over-tension V-belts. Over-tensioning will shorten both V-belt and bearing life. Under-tensioning will cause belt slippage. Always keep belts free from dirt, grease, oil and other foreign material which may cause slippage.

Tension Measurement

Correct V-belt tension can be achieved using a V-belt tension tester and Table 1 or 2. Use the tables to find the V-belt size (cross-section), the smallest sheave diameter, the belt type for your application. The corresponding deflection force required for new or used belts is shown opposite the RPM range of the pump.

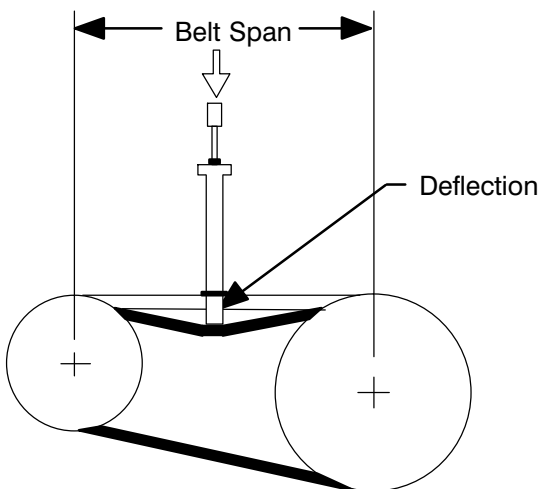

Figure B-6. Belt Tension Measurement

The ratio of deflection to belt span is 1:64 for both ASA and metric units. Therefore, a belt with a span of 64 inches would require a deflection of 1 inch at the force shown on the Tables for your particular application.

For example, if the span as measured in Figure 8 is 32 inches (813 mm), the v-belt cross-section is C, the smallest sheave diameter is 8 inches, the pump speed is 1250 RPM, and the belts are uncogged Hy-T type, then 11.5 lbs. of force on the tensioner should show 1/2-inch (12,7 mm) of deflection.

A tension tester is available as an option from Gorman-Rupp (P/N 29513-001). Other tension testers are available from your local belt/sheave distributor, and work on a similar principal.

To use the Gorman-Rupp tensioner, measure the belt span as shown in Figure B-6. Position the bottom of the large O-ring on the span scale of the tensioner at the measured belt span. Set the small O-ring on the deflection force scale to zero.

Place the tension tester squarely on the belt at the center of the belt span. Apply force on the plunger, perpendicular to the belt span, until the bottom of the large O-ring is even with the top of the next belt, or with the bottom of a straight edge laid across the sheaves.

Read the force applied from the bottom of the small O-ring on the deflection force scale. Compare this force with the value shown in Table 1 or 2 and adjust the tension accordingly. Note that the **tension for new belts is higher than that for used belts** to allow for expected belt stretching. **Do not** over-tension used belts to the higher deflection forces shown for new belts.

Table 1. Belt Deflection

Sheave Dia. (Inches) Deflection Force (Lbs.)

Sheave Dia. (MM) Deflection Force (Kg.)

Cross Section	Smallest Sheave Diameter Range	R.P.M. Range	Belt Deflection Force			
			Uncogged Hy-T Belts & Uncogged Hy-T Torque Team		Cogged Torque-Flex & Machined Edge torque Team Belts	
			Used Belt	New Belt	Used Belt	New Belt
A,AX	3.0 - 3.6	1000-2500 2501-4000	3.7 2.8	5.5 4.2	4.1 3.4	6.1 5.0
	3.8 - 4.8	1000-2500 2501-4000	4.5 3.8	6.8 5.7	5.0 4.3	7.4 6.4
	5.0 - 7.0	1000-2500 2501-4000	5.4 4.7	8.0 7.0	5.7 5.1	9.4 7.4
B,BX	3.4 - 4.2	860-2500 2501-4000			4.9 4.2	7.2 6.2
	4.4 - 5.6	860-2500 2501-4000	5.3 4.5	7.9 6.7	7.1 7.1	10.5 9.1
	5.8 - 8.6	860-2500 2501-4000	6.3 6.0	9.4 8.9	8.5 7.3	12.6 10.9
C,CX	7.0 - 9.0	500-1740 1741-3000	11.5 9.4	17.0 13.8	14.7 11.9	21.8 17.5
	9.5 - 16.0	500-1740 1741-3000	14.1 12.5	21.0 18.5	15.9 14.6	23.5 21.6
D	12.0 - 16.0	200-850 851-1500	11.5 9.4	17.0 13.8	14.7 11.9	21.8 17.5
	18.0 - 20.0	200-850 851-1500	30.4 25.6	45.2 38.0		
3V, 3VX	2.2 - 2.4	1000-2500 2501-4000			3.3 2.9	4.9 4.3
	2.65 - 3.65	1000-2500 2501-4000	3.6 3.0	5.1 4.4	4.2 3.8	6.2 5.6
	4.12 - 6.90	1000-2500 2501-4000	4.9 4.4	7.3 6.6	5.3 4.9	7.9 7.3
5V, 5VX	4.4 - 6.7	500-1749 1750-3000 3001-4000			10.2 8.8 5.6	15.2 13.2 8.5
	7.1 - 10.9	500-1740 1741-3000	12.7 11.2	18.9 16.7	14.8 13.7	22.1 20.1
	11.8 - 16.0	500-1740 1741-3000	15.5 14.6	23.4 21.8	17.1 16.8	25.5 25.0
8V	12.5 - 17.0	200-850 851-1500	33.0 26.8	49.3 39.9		
	18.0 - 22.4	200-850 851-1500	39.6 35.3	59.2 52.7		

Cross Section	Smallest Sheave Diameter Range	R.P.M. Range	Belt Deflection Force			
			Uncogged Hy-T Belts & Uncogged Hy-T Torque Team		Cogged Torque-Flex & Machined Edge torque Team Belts	
			Used Belt	New Belt	Used Belt	New Belt
A,AX	75 - 90	1000-2500 2501-4000	1.7 1.3	2.5 1.9	1.9 1.5	2.8 2.3
	91 - 120	1000-2500 2501-4000	2.0 1.7	3.1 2.6	2.3 2.0	3.4 2.9
	125 - 175	1000-2500 2501-4000	2.4 2.1	3.6 3.2	2.6 2.3	4.3 3.4
B,BX	85 - 105	860-2500 2501-4000			2.2 1.9	3.3 2.8
	106 - 140	860-2500 2501-4000	2.4 2.0	3.6 3.0	3.2 3.2	4.8 4.1
	141 - 220	860-2500 2501-4000	2.9 2.7	4.3 4.0	3.9 3.3	5.7 4.9
C,CX	175 - 230	500-1740 1741-3000	5.2 4.3	7.7 6.3	6.7 5.4	9.9 7.9
	231 - 400	500-1740 1741-3000	6.4 5.7	9.5 8.4	7.2 6.6	10.7 9.8
D	305 - 400	200-850 851-1500	11.3 9.6	16.8 14.2		
	401 - 510	200-850 851-1500	13.8 11.6	20.5 17.2		
3V, 3VX	55 - 60	1000-2500 2501-4000			1.5 1.3	2.2 2.0
	61 - 90	1000-2500 2501-4000	1.6 1.4	2.3 2.0	1.9 1.7	2.8 2.5
	91 - 175	1000-2500 2501-4000	2.2 2.0	3.3 3.0	2.4 2.2	3.6 3.3
5V, 5VX	110 - 170	500-1749 1750-3000 3001-4000			4.6 4.0 2.5	6.9 6.0 3.9
	171 - 1275	500-1740 1741-3000	5.8 5.1	8.6 7.6	6.7 6.2	10.0 9.1
	276 - 400	500-1740 1741-3000	7.0 6.6	10.6 9.9	7.8 7.6	11.6 11.3
8V	315 - 430	200-850 851-1500	15.0 12.2	22.4 18.1		
	431 - 570	200-850 851-1500	18.0 16.0	26.8 23.9		

ELECTRICAL CONNECTIONS

Before connecting a motor to the incoming power, check that the electrical service available matches the pump motor requirements stamped on the motor nameplate.

If rotation is incorrect on a three-phase motor, have a qualified electrician interchange any two of the three phase wires to change direction. If rotation is incorrect on a single-phase motor, consult the literature supplied with the motor for specific instructions.



The electrical power used to operate the pump is high enough to cause injury or

death. Obtain the services of a qualified electrician to make all electrical connections.



Do not install and operate a non-explosion proof motor in an explosive atmosphere. Install, connect, and operate the motor in accordance with The National Electrical Code and all local codes. If there is a conflict between the instructions in the manual accompanying the unit and The National Electrical Code or the applicable local code, The National or local code shall take precedence.

OPERATION – SECTION C

Review all **SAFETY** information in Section A.

Follow the instructions on all tags, labels and decals attached to the pump.



This pump is designed to handle most non-volatile, non-flammable liquids containing specified entrained solids. Do not attempt to pump volatile, corrosive or flammable liquids which may damage the pump or endanger personnel as a result of pump failure.

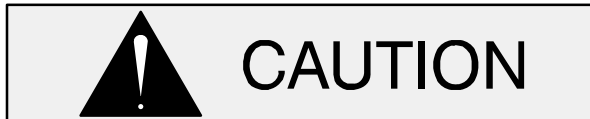

Pump speed and operating condition points must be within the continuous performance range shown on the curve (see Section E, Page 1).

PRIMING

Install the pump and piping as described in **INSTALLATION**. Make sure that the piping connections are tight, and that the pump is securely mounted. Check that the pump is properly lubricated (see **LUBRICATION** in **MAINTENANCE AND REPAIR**).

This pump is self-priming, but the pump should never be operated unless there is liquid in the pump casing.



Never operate this pump unless there is liquid in the pump casing. The pump will not prime when dry. Extended operation of a dry pump will destroy the seal assembly.

Add liquid to the pump casing when:

1. The pump is being put into service for the first time.
2. The pump has not been used for a considerable length of time.
3. The liquid in the pump casing has evaporated.

Once the pump casing has been filled, the pump will prime and reprime as necessary.



After filling the pump casing, reinstall and tighten the fill plug. Do not attempt to operate the pump unless all connecting piping is securely installed. Otherwise, liquid in the pump forced out under pressure could cause injury to personnel.

To fill the pump, remove the pump casing fill cover or fill plug in the top of the casing, and add clean liquid until the casing is filled. Replace the fill cover or fill plug before operating the pump.

STARTING

Consult the operations manual furnished with the power source.

Rotation

The pump could be damaged and performance adversely affected by incorrect rotation. If pump performance is not within the specified limits (see the curve on page E-1), check the direction of power source rotation before further troubleshooting.



The pump must operate in the direction indicated by the arrow on the pump, or accompanying decals.

Consult the operating manual furnished with the pump power source before attempting to start the power source.

If an electric motor is used to drive the pump, remove V-belts, couplings, or otherwise disconnect the pump from the motor before checking motor rotation. Operate the motor independently while observing the direction of the motor shaft, or cooling fan.

If rotation is incorrect on a three-phase motor, have a qualified electrician interchange any two of the three phase wires to change direction. If rotation is incorrect on a single-phase motor, consult the literature supplied with the motor for specific instructions.

OPERATION

Lines With a Bypass

If a Gorman-Rupp Automatic Air Release Valve has been installed, the valve will automatically open to allow the pump to prime, and automatically close after priming is complete (see **INSTALLATION** for Air Release Valve operation).

If the bypass line is open, air from the suction line will be discharged through the bypass line back to the wet well during the priming cycle. Liquid will then continue to circulate through the bypass line while the pump is in operation.

Lines Without a Bypass

Open all valves in the discharge line and start the power source. Priming is indicated by a positive reading on the discharge pressure gauge or by a quieter operation. The pump may not prime immediately because the suction line must first fill with liquid. If the pump fails to prime within five minutes, stop it and check the suction line for leaks.

After the pump has been primed, partially close the discharge line throttling valve in order to fill the line slowly and guard against excessive shock pressure which could damage pipe ends, gaskets, sprinkler heads, and any other fixtures connected to the line. When the discharge line is completely filled, adjust the throttling valve to the required flow rate.

Leakage

No leakage should be visible at pump mating surfaces, or at pump connections or fittings. Keep all line connections and fittings tight to maintain maximum pump efficiency.

Liquid Temperature And Overheating

The **maximum** liquid temperature for this pump is 160° F (71° C). Do not apply it at a higher operating temperature.

Overheating can occur if operated with the valves in the suction or discharge lines closed. Operating against closed valves could bring the liquid to a boil, build pressure, and cause the pump to rupture or explode. If overheating occurs, stop the pump and allow it to cool before servicing it. Refill the pump casing with cool liquid.



Allow an over-heated pump to cool before servicing. Do not remove plates, covers, gauges, or fittings from an over-heated pump. Liquid within the pump can reach boiling temperatures, and vapor pressure within the pump can cause parts being disengaged to be ejected with great force. After the pump cools, drain the liquid from the pump by removing the casing drain plug. Use caution when removing the plug to prevent injury to personnel from hot liquid.

As a safeguard against rupture or explosion due to heat, this pump is equipped with a pressure relief valve which will open if vapor pressure within the pump casing reaches a critical point. If overheating does occur, stop the pump immediately and allow it to cool before servicing it. **Approach any over-heated pump cautiously.** It is recommended that the pressure relief valve assembly be replaced at each overhaul, or any time the pump casing overheats and activates the valve. **Never** replace this valve with a substitute which has not been specified or provided by the Gorman-Rupp Company.

Strainer Check

If a suction strainer has been shipped with the pump or installed by the user, check the strainer

regularly, and clean it as necessary. The strainer should also be checked if pump flow rate begins to drop. If a vacuum suction gauge has been installed, monitor and record the readings regularly to detect strainer blockage.

Never introduce air or steam pressure into the pump casing or piping to remove a blockage. This could result in personal injury or damage to the equipment. If backflushing is absolutely necessary, **liquid pressure** must be limited to 50% of the maximum permissible operating pressure shown on the pump performance curve (see Section E, Page 1).

Pump Vacuum Check

With the pump inoperative, install a vacuum gauge in the system, using pipe dope on the threads. Block the suction line and start the pump. At operating speed the pump should pull a vacuum of 20 inches (508,0 mm) or more of mercury. If it does not, check for air leaks in the seal, gasket, or discharge valve.

Open the suction line, and read the vacuum gauge with the pump primed and at operating speed. Shut off the pump. The vacuum gauge reading will immediately drop proportionate to static suction lift, and should then stabilize. If the vacuum reading falls off rapidly after stabilization, an air leak exists. Before checking for the source of the leak, check the point of installation of the vacuum gauge.

STOPPING

Never halt the flow of liquid suddenly. If the liquid being pumped is stopped abruptly, damaging shock waves can be transmitted to the pump and piping system. Close all connecting valves slowly.



If the application involves a high discharge head, gradually close the discharge throttling valve before stopping the pump.

After stopping the pump, disconnect the power source or lock it out to ensure that the pump will remain inoperative.

Cold Weather Preservation

In below freezing conditions, drain the pump to prevent damage from freezing. Also, clean out any solids by flushing with a hose. Operate the pump for approximately one minute; this will remove any remaining liquid that could freeze the pump rotating parts. If the pump will be idle for more than a few hours, or if it has been pumping liquids containing a large amount of solids, drain the pump, and flush it thoroughly with clean water. To prevent large solids from clogging the drain port and preventing the pump from completely draining, insert a rod or stiff wire in the drain port, and agitate the liquid during the draining process. Clean out any remaining solids by flushing with a hose.

BEARING TEMPERATURE CHECK

Bearings normally run at higher than ambient temperatures because of heat generated by friction. Temperatures up to 160°F (71°C) are considered normal for bearings, and they can operate safely to at least 180°F (82°C).

Checking bearing temperatures by hand is inaccurate. Bearing temperatures can be measured accurately by placing a contact-type thermometer against the housing. Record this temperature for future reference.

A sudden increase in bearing temperatures is a warning that the bearings are at the point of failing to operate properly. Make certain that the bearing lubricant is of the proper viscosity and at the correct level (see **LUBRICATION** in Section E). Bearing overheating can also be caused by shaft misalignment and/or excessive vibration.

When pumps are first started, the bearings may seem to run at temperatures above normal. Continued operation should bring the temperatures down to normal levels.

TROUBLESHOOTING – SECTION D

Review all SAFETY information in Section A.



Before attempting to open or service the pump:

1. Familiarize yourself with this manual.
2. Disconnect or lock out the power source to ensure that the pump will remain inoperative.
3. Allow the pump to completely cool if overheated.
4. Check the temperature before opening any covers, plates, or plugs.
5. Close the suction and discharge valves.
6. Vent the pump slowly and cautiously.
7. Drain the pump.

TROUBLE	POSSIBLE CAUSE	PROBABLE REMEDY
PUMP FAILS TO PRIME	<p>Not enough liquid in casing.</p> <p>Suction check valve contaminated or damaged.</p> <p>Air leak in suction line.</p> <p>Lining of suction hose collapsed.</p> <p>Leaking or worn seal or pump gasket.</p> <p>Suction lift or discharge head too high.</p> <p>Strainer clogged.</p>	<p>Add liquid to casing. See PRIMING.</p> <p>Clean or replace check valve.</p> <p>Correct leak.</p> <p>Replace suction hose.</p> <p>Check pump vacuum. Replace leaking or worn seal or gasket.</p> <p>Check piping installation and install bypass line if needed. See INSTALLATION.</p> <p>Check strainer and clean if necessary.</p>
PUMP STOPS OR FAILS TO DELIVER RATED FLOW OR PRESSURE	<p>Air leak in suction line.</p> <p>Lining of suction hose collapsed.</p> <p>Suction intake not submerged at proper level or sump too small.</p>	<p>Correct leak.</p> <p>Replace suction hose.</p> <p>Check installation and correct submergence as needed.</p>

TROUBLE	POSSIBLE CAUSE	PROBABLE REMEDY
PUMP STOPS OR FAILS TO DELIVER RATED FLOW OR PRESSURE (cont.)	<p>Impeller or other wearing parts worn or damaged.</p> <p>Leaking or worn seal or pump gasket.</p> <p>Impeller clogged.</p> <p>Pump speed too slow.</p> <p>Pump running backwards.</p> <p>Suction lift or discharge head too high.</p>	<p>Replace worn or damaged parts. Check that impeller is properly centered and rotates freely.</p> <p>Check pump vacuum. Replace leaking or worn seal or gasket.</p> <p>Free impeller of debris.</p> <p>Check driver output; check belts or couplings for slippage.</p> <p>Check direction of rotation and correct by interchanging any two motor leads at control box. (See Pump Rotation, Section C).</p> <p>Check piping installation and install bypass line if needed. See INSTALLATION.</p>
PUMP REQUIRES TOO MUCH POWER	<p>Pump speed too high.</p> <p>Discharge head too low.</p> <p>Liquid solution too thick.</p>	<p>Check driver output check that sheaves or couplings are correctly sized.</p> <p>Adjust discharge valve.</p> <p>Dilute if possible.</p>
PUMP CLOGS FREQUENTLY	<p>Discharge flow too slow.</p> <p>Suction check valve or foot valve clogged or binding.</p>	<p>Open discharge valve fully to increase flow rate, and run power source at maximum governed speed.</p> <p>Clean valve.</p>
EXCESSIVE NOISE	<p>Cavitation in pump.</p> <p>Pumping entrained air.</p> <p>Pump or drive not securely mounted.</p> <p>Impeller clogged or damaged.</p>	<p>Reduce suction lift and/or friction losses in suction line. Record vacuum and pressure gauge readings and consult local representative or factory.</p> <p>Locate and eliminate source of air bubble.</p> <p>Secure mounting hardware.</p> <p>Clean out debris; replace damaged parts.</p>
BEARINGS RUN TOO HOT	<p>Bearing temperature is high, but within limits.</p> <p>Low or incorrect lubricant.</p> <p>Suction and discharge lines not properly supported.</p> <p>Drive misaligned.</p>	<p>Check bearing temperature regularly to monitor any increase.</p> <p>Check for proper type and level of lubricant.</p> <p>Check piping installation for proper support.</p> <p>Align drive properly.</p>

PREVENTIVE MAINTENANCE

Routine preventive maintenance of the pump will maintain peak operating performance. Since pump applications are seldom identical, and pump wear is directly affected by such things as the abrasive qualities, pressure and temperature of the liquid being pumped, this section is intended only to provide general recommendations and practices for preventive maintenance. Regardless of the application however, following a routine preventive maintenance schedule will help assure trouble-free performance and long life from your Gorman-Rupp pump.

Record keeping is an essential component of a good preventive maintenance program. Changes in suction and discharge gauge readings (if so equipped) between regularly scheduled inspections can indicate problems that can be corrected before system damage or catastrophic failure occurs. The appearance of wearing parts should also be documented at each inspection for comparison as well. Also, if records indicate that a certain part (such as the seal) fails at approximately the same duty cycle, the part can be checked and replaced before failure occurs, reducing unscheduled down time.

Preventive Maintenance Schedule					
Item	Service Interval*				
	Daily	Weekly	Monthly	Semi-Annually	Annually
General Condition (Temperature, Unusual Noises or Vibrations, Cracks, Leaks, Loose Hardware, Etc.)	I				
Pump Performance (Gauges, Speed, Flow)	I				
Bearing Lubrication		I			R
Seal Lubrication (And Packing Adjustment, If So Equipped)		I			R
V-Belts (If So Equipped)			I		
Air Release Valve Plunger Rod (If So Equipped)			I	C	
Front Impeller Clearance (Wear Plate)				I	
Rear Impeller Clearance (Seal Plate)				I	
Check Valve					I
Pressure Relief Valve (If So Equipped)					C
Pump and Driver Alignment					I
Shaft Deflection					I
Bearings					I
Bearing Housing					I
Piping					I
Driver Lubrication – See Mfgr’s Literature					I
Legend: I = Inspect, Clean, Adjust, Repair or Replace as Necessary C = Clean R = Replace * Service interval based on an intermittent duty cycle equal to approximately 4000 hours annually. Adjust schedule as required for lower or higher duty cycles or extreme operating conditions.					

PUMP MAINTENANCE AND REPAIR - SECTION E

MAINTENANCE AND REPAIR OF THE WEARING PARTS OF THE PUMP WILL MAINTAIN PEAK OPERATING PERFORMANCE.

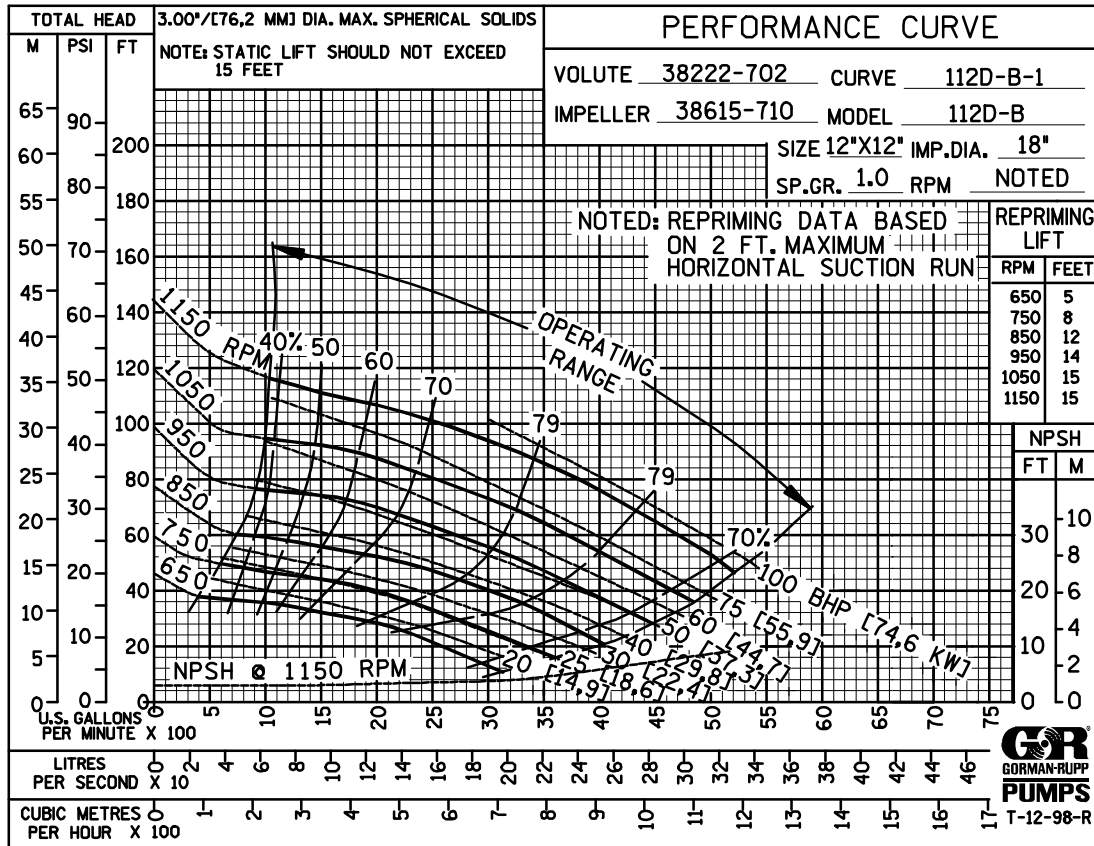

*** STANDARD PERFORMANCE FOR PUMP MODEL 112D60-B, Including /WW**

* Based on 70° F (21° C) clear water at sea level with minimum suction lift. Since pump installations are seldom identical, your performance may be different due to such factors as viscosity, specific gravity, elevation, temperature, and impeller trim.

Contact the Gorman-Rupp Company to verify performance or part numbers.

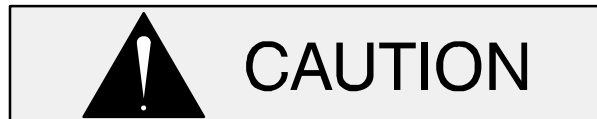

Pump speed and operating condition points must be within the continuous performance range shown on the curve.

If your pump serial number is followed by an "N", your pump is **NOT** a standard production model.

SECTION DRAWING

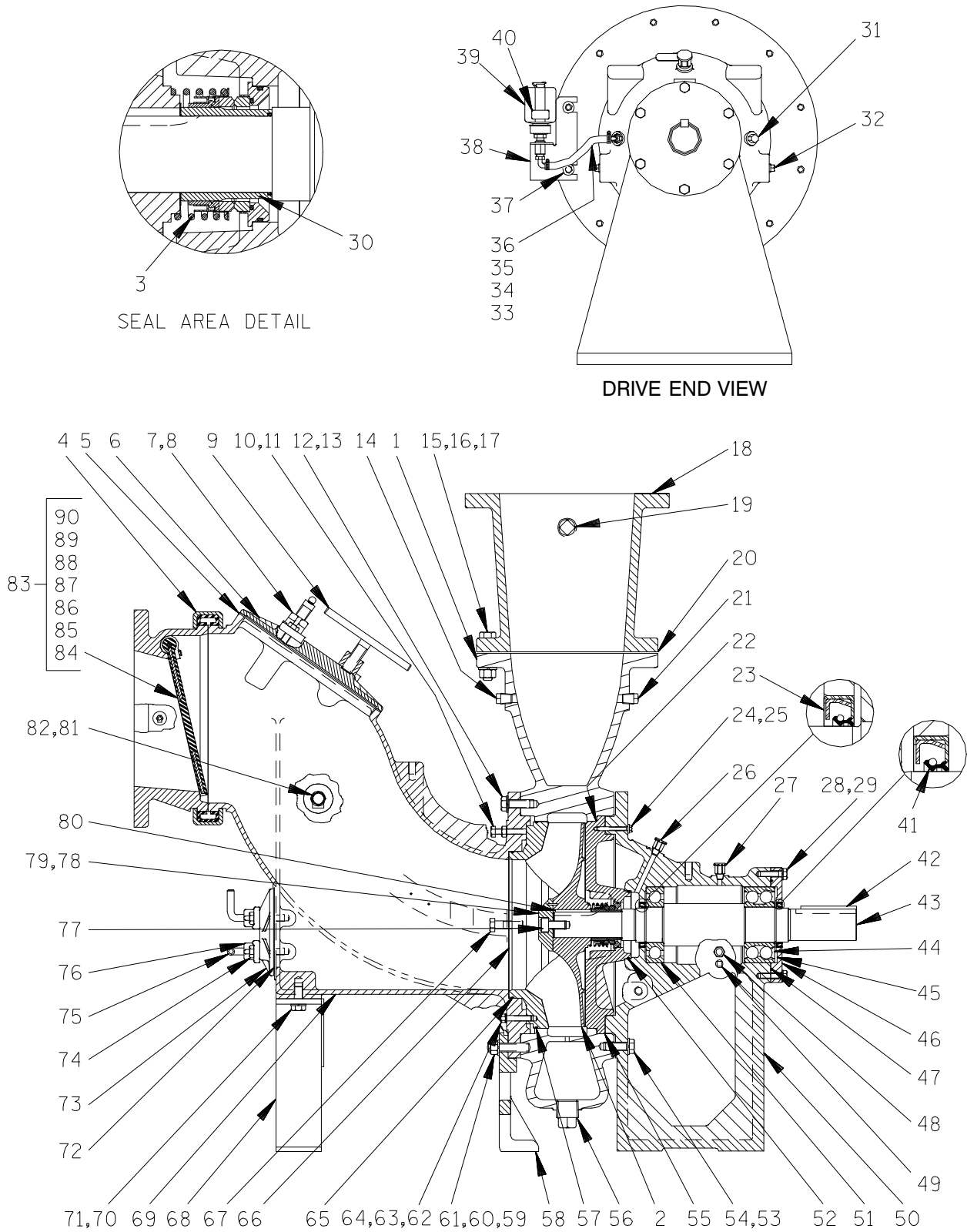

Figure 1. Pump Model 112D60-B, Including /WW

PARTS LIST

Pump Model 112D60-B, Including /WW (From S/N 1288322 Up)

If your pump serial number is followed by an "N", your pump is **NOT** a standard production model. Contact the Gorman-Rupp Company to verify part numbers.

ITEM NO.	PART NAME	PART NUMBER	MAT'L CODE	QTY	ITEM NO.	PART NAME	PART NUMBER	MAT'L CODE	QTY
1	PUMP CASING	38222-702	10010	1	62	STUD	C0814	15991	4
2 *	IMPELLER	38615-710	11030	1	63	LOCK WASHER	J08	15991	4
3 *	SEAL ASSEMBLY	46512-259	----	1	64	HEX NUT	D08	15991	4
4	VICTAULIC CPLG	25552-214	----	1	65 *	WEAR PLATE O-RING	25152-278	----	1
5 *	GASKET	38688-015	20000	1	66 *	WEAR PLATE	38691-808	11030	1
6	COVER PLATE ASSY	48271-026	----	1	67	HEX HD CAP SCREW	B1210	15991	2
7	CLAMP	12872	11010	2	68	SUCT ELBOW SUPPORT	41881-258	24150	1
8	MACHINE BOLT	A1011	15991	4	69	SUCTION ELBOW	38647-910	10010	1
9	SCREW ASSEMBLY	2536	24000	2	70	HEX HD CAP SCREW	B1206	15991	2
10	TAP BOLT	21612-199	----	4	71	LOCK WASHER	J12	15991	2
11	JAM NUT	AT08	15991	4	72 *	COVER PLATE GASKET	38682-016	20000	1
12	HEX HD CAP SCREW	B1209	15991	8	73	COVER PLATE ASSY	48271-025	----	1
13	LOCK WASHER	J12	15991	8	74	MACHINE BOLT	A1011	15991	4
14	PIPE PLUG	P08	15991	1	75	SCREW CLAMP BAR	31912-009	15000	2
15	HEX HD CAP SCREW	B1416	15991	12	76	CLAMP BAR	38111-310	11010	2
16	LOCK WASHER	J14	15991	12	77 *	SOC HD CAP SCREW	BD1206	15990	1
17	HEX NUT	D14	15991	12	78 *	IMPELLER WASHER	31167-012	15030	1
18	REDUCER 10 X 12	38642-620	10000	1	79 *	ROLL PIN	S2197	----	1
19	PIPE PLUG	P16	10009	1	80 *	IMPELLER KEY	N0812	15990	1
20 *	FLANGE GASKET	2751G	18000	1	81 *	PRESS RELIEF VALVE	26662-005	----	1
21	PIPE PLUG	P08	15079	1	82	PIPE PLUG	P08	15079	1
22 *	PUMP CASING O-RING	25152-283	----	1	83	CHECK VALVE ASSY	46421-035	----	1
23 *	INTERMEDIATE OIL SEAL	25258-851	----	1	84	-HEX HD CAP SCREW	B0606	15991	2
24	HEX HD CAP SCREW	B0610	15991	2	85	-PIPE PLUG	P08	15079	2
25	LOCK WASHER	J06	15991	2	86	-FLAT WASHER	KB08	17000	2
26	AIR VENT	S1703	----	1	87	-PIVOT CAP	38141-003	11060	2
27	AIR VENT	S1703	----	1	88	-CHECK VALVE BODY	38341-806	10010	1
28	HEX HD CAP SCREW	B0808	15991	6	89	-T-TYPE LK WASHER	AK06	15991	2
29	LOCK WASHER	J08	15991	6	90 *	-FLAP VALVE ASSY	46411-068	24010	1
30 *	SHAFT SLEEVE	31513-051	17200	1					
31	PIPE PLUG	P06	15079	1					
32	PIPE PLUG	P06	15079	2					
33	BARBED ELBOW	26523-506	----	1					
34	MALE CONNECTOR	26523-409	----	1					
35	RUB HOSE 3/8 X 7.00 LG	31411-227	19360	1					
36	HOSE CLAMP	26518-642	----	2					
37	FLAT WASHER	K12	15991	2					
38	BTL OILER BRKT ASSY	41881-617	24150	1					
39	BOTTLE OILER	26713-004	----	1					
40	OIL LEVEL DECAL	38816-123	----	1					
41 *	BEARING CAP OIL SEAL	25258-851	----	1					
42 *	SHAFT KEY	N1020	15990	1					
43 *	IMPELLER SHAFT	38512-519	16040	1					
44 *	OUTBOARD BALL BRG	23421-417	----	1					
45 *	WAVE WASHER	23963-333	----	3					
46	BEARING COVER	38322-419	10010	1					
47 *	BEARING CAP O-RING	S1874	----	1					
48	SIGHT GAGE	26714-011	----	1					
49	PIPE PLUG	P06	15079	3					
50	PEDESTAL	38257-511	10010	1					
51 *	INBOARD BALL BEARING	23275-017	----	1					
52 *	SEAL PLATE O-RING	25152-256	----	1					
53	HEX HD CAP SCREW	B1210	15991	12					
54	LOCK WASHER	J12	15991	12					
55	SEAL PLATE	38272-706	10010	1					
56	PIPE PLUG	P24	10009	1					
57 *	WEAR PLATE O-RING	25152-283	----	1					
58	PEDESTAL FOOT	38151-002	10010	1					
59	STUD	C1216	15991	4					
60	LOCK WASHER	J12	15991	4					
61	HEX NUT	D12	15991	4					

NOT SHOWN:				
	NAME PLATE	2613D	13990	1
	ROTATION DECAL	2613M	----	1
	DRIVE SCREW	BM#04-03	17000	4
	LUBE DECAL	38816-079	----	1
	WARNING DECAL	38816-302	----	1
	G-R DECAL	GR-06	----	1
	INSTRUCTION LABEL	2613DK	----	1
	WARNING DECAL	2613FE	----	1
	INSTRUCTION TAG	38817-011	----	1
	INSTRUCTION TAG	38817-024	----	1
	SUCTION STICKER	6588AG	----	1
	DISCHARGE STICKER	6588BJ	----	1
OPTIONAL:				
G-R HARD IRON PARTS:				
	-IMPELLER	38615-710	1016H	1
	-WEAR PLATE	38691-808	1016H	1
PRESSURE RELIEF VALVE:				
	-SEWAGE SLUDGE	46431-628	----	1
CASING HEATER ASSY:				
	-120V	47811-062	----	1
	-240V	47811-063	----	1
HI TEMP SHUT-DOWN KITS:				
	-145° F	48313-186	----	1
	-130° F	48313-256	----	1
	-120° F	48313-257	----	1

* INDICATES PARTS RECOMMENDED FOR STOCK

PUMP AND SEAL DISASSEMBLY AND REASSEMBLY

Review all SAFETY information in Section A.

Follow the instructions on all tags, label and decals attached to the pump.

This pump requires little service due to its rugged, minimum-maintenance design. However, if it becomes necessary to inspect or replace the wearing parts, follow these instructions which are keyed to the sectional view (see Figure E-1) and the accompanying parts list.

This manual will alert personnel to known procedures which require special attention, to those which could damage equipment, and to those which could be dangerous to personnel. However, this manual cannot possibly anticipate and provide detailed precautions for every situation that might occur during maintenance of the unit. Therefore, it is the responsibility of the owner/maintenance personnel to ensure that **only** safe, established maintenance procedures are used, and that any procedures not addressed in this manual are performed **only** after establishing that neither personal safety nor pump integrity are compromised by such practices.

Before attempting to service the pump, disconnect or lock out the power source to ensure that the pump will remain inoperative. Close all valves in the suction and discharge lines.

For power source disassembly and repair, consult the literature supplied with the power source, or contact your local power source representative.



Before attempting to open or service the pump:

1. **Familiarize yourself with this manual.**
2. **Disconnect or lock out the power source to ensure that the pump will remain inoperative.**
3. **Allow the pump to completely cool if overheated.**

4. **Check the temperature before opening any covers, plates, or plugs.**
5. **Close the suction and discharge valves.**
6. **Vent the pump slowly and cautiously.**
7. **Drain the pump.**

Suction Check Valve Removal and Disassembly

Before attempting to service the pump, remove the pump casing drain plug (56) and drain the pump. Clean and reinstall the drain plug.

To service the suction check valve assembly (83), loosen the cover clamp screws (9) and remove the cover clamps (7) securing the cover plate assembly (5) to the suction elbow (69). Remove the cover plate gasket (6) and replace as required.

Reach through the access opening and remove the hardware (84 and 89) and pivot caps (87) securing the check valve (90) to the check valve body (88). Remove the check valve through the access opening.

Inspect the check valve for wear or damage. If replacement is required, remove the flat washers (86) from the pivot arm. Tie and tag the washers for future reference.

If the check valve body (88) needs replaced, remove the hardware securing the suction piping. Remove the "Victaulic" coupling (4) and separate the valve body from the suction elbow. Inspect the rubber "Victaulic" gasket for damage and replace as required.

If no further disassembly is required, see **Suction Check Valve Installation**.

Wear Plate And Suction Elbow Removal

Service to the wear plate (66), impeller (2) or seal assembly (3) can be accomplished from either side of the pump casing (1). The following instructions are based on service from the suction side of the pump.

Install a 3/4-10 UNC-2B lifting eye (not supplied) in the tapped hole located in the suction elbow. Be sure the eye bolt is fully engaged before attaching

a hoist. Support the suction elbow using a suitable hoist and sling. The hoist is used to support the suction elbow only, **do not** try to lift the pump. Remove the hardware securing the elbow support (68) and pedestal foot (58) to the base.



Do not attempt to lift the complete pump using the lifting eye. It is designed to facilitate removal or installation of individual components only. Additional weight could cause damage to the pump or failure of the eye bolt, resulting in possible serious personnel injury.

Remove the hardware (12, 13, 60 and 61) securing the suction elbow to the pump casing (1). Use the jacking screws (67) to force the suction head out of the pump casing. Tie and tag any leveling shims used under the supports (58 and 68) to ease reassembly.

Inspect the wear plate and O-ring (57) for damage or wear. If the wear plate must be replaced, remove the hardware (63 and 64) from the wear plate studs (62). Loosen the jam nuts (11) and use the adjusting screws (10) to press the wear plate from the suction elbow. If replacement is required, remove the O-rings (57 and 65) from the wear plate.

Impeller Removal

Before attempting to remove the impeller, immobilize the impeller by wedging a block of wood between the vanes and the pump casing. Remove the impeller capscrew, washer and roll pin (77, 78 and 79). Remove the wood block and install two 3/8–16 UNC–2B capscrews (not supplied) in the tapped holes in the impeller hub. Use a suitable puller to remove the impeller from the shaft (43). Retain the impeller key (80).

Remove the impeller adjusting shims (not shown). For ease of reassembly, tie and tag the shims or measure and record thickness.

Seal Removal and Disassembly

NOTE

*There is an air filled cavity with an open drain hole toward the bottom of the pedestal directly behind the seal plate (55). If oil escapes from the drain hole, the seal plate O-ring (52) has failed and removal of the seal plate is required. The drain hole is tapped, but **do not** install a pipe plug in the drain hole..*

(Figures E–1 and E–3)

Before removing the seal, disconnect the hose (35) from the connector (34) and plug the tube to stop the flow of oil from the bottle oiler (39). Remove the connector (34) and allow the seal cavity to drain.

NOTE

The oil will not drain below the hole for the connector. To drain the remaining oil from the seal cavity, remove one of the pipe plugs (32) and drain the remaining oil into a pan.

Remove the seal spring. Slide the shaft sleeve (30) and rotating portion of the seal off the shaft as a unit. Remove the shaft sleeve O-ring. Apply oil to the sleeve and work it up under the bellows. Slide the rotating portion of the seal off the shaft sleeve.

Use a pair of stiff wires with hooked ends to remove the stationary element, seat and O-rings from the seal plate.

Clean the seal cavity and shaft with a soft cloth soaked in cleaning solvent.



Most cleaning solvents are toxic and flammable. Use them only in a well ventilated area free from excessive heat, sparks, and flame. Read and follow all precautions printed on solvent containers.

If no further disassembly is required, see **Seal Reassembly and Installation**.

Pump Disassembly

Remove the discharge piping. If disassembly is required, remove the hardware (15, 16 and 17) se-

curing the reducer (18) and flange gasket (20) to the pump casing (1).

Remove the hardware (37) securing the bottle oiler bracket (38) to the pedestal (50). Use a suitable hoist and sling to support the pump casing, and remove the remaining hardware (53 and 54). Separate the casing from the pedestal assembly.

Remove the seal plate O-ring (22).

Separate the seal plate (55) from the pedestal by removing the hardware (24 and 25). Remove the seal plate O-ring (52).

Shaft and Bearing Removal and Disassembly

To separate the pedestal (50) from the power source, install a lifting eye (not supplied) in the 3/8–18 NPT tapped hole in the pedestal. Be sure the eye is fully engaged before attaching a hoist. Remove the mounting hardware and separate the pedestal from the power source. Tie and tag any shims used under the mounting foot. Remove the shaft key (42).



Do not attempt to lift the complete pump unit using the lifting eye. It is designed to facilitate removal or installation of individual components only. Additional weight may result in damage to the pump or failure of the eye bolt.

Before opening the pedestal, drain the lubricant from the pedestal by removing the drain plug (49). Clean and reinstall the plug.

When the pump is properly operated and maintained, the pedestal should not require disassembly. Disassemble the shaft and bearings **only** when there is evidence of wear or damage.

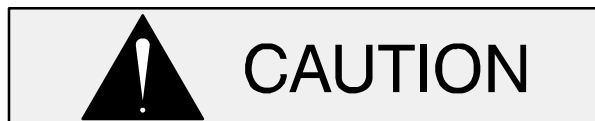

Shaft and bearing disassembly in the field is not recommended. These operations should be performed only in a properly-equipped shop by qualified personnel.

Remove the hardware (28 and 29) securing the bearing cover (46) to the pedestal. Remove the wave washer (45) and O-ring (47). Inspect the oil seal (41) and, if replacement is required, press it from the bearing cover.

Place a block of wood against the impeller end of the shaft (43) and tap the shaft and assembled bearings (44 and 51) from the pedestal bore. **Be careful** not to damage the shaft.

Inspect the oil seal (23) and, if replacement is required, press it from the pedestal.

After removing the shaft and bearings, clean and inspect the bearings **in place** as follows.



To prevent damage during removal from the shaft, it is recommended that bearings be cleaned and inspected **in place**. It is **strongly** recommended that the bearings be replaced **any** time the shaft and bearings are removed.

Clean the pedestal, shaft and all component parts (except the bearings) with a soft cloth soaked in cleaning solvent. Inspect the parts for wear or damage and replace as necessary.



Most cleaning solvents are toxic and flammable. Use them only in a well ventilated area free from excessive heat, sparks, and flame. Read and follow all precautions printed on solvent containers.

Clean the bearings thoroughly in **fresh** cleaning solvent. Dry the bearings with filtered compressed air and coat with light oil.



Bearings must be kept free of all dirt and foreign material. Failure to do so will greatly shorten bearing life. **Do not** spin dry

bearings. This may scratch the balls or races and cause premature bearing failure.

Rotate the bearings by hand to check for roughness or binding and inspect the bearing balls. If rotation is rough or the bearing balls are discolored, replace the bearings.

The bearing tolerances provide a tight press fit onto the shaft and a snug slip fit into the pedestal. Replace the bearings, shaft, or pedestal if the proper bearing fit is not achieved.

If bearing replacement is required, use a bearing puller to remove them from the shaft.

Shaft and Bearing Reassembly and Installation

Clean and inspect the bearings as indicated in **Shaft and Bearing Removal and Disassembly**.



To prevent damage during removal from the shaft, it is recommended that bearings be cleaned and inspected **in place**. It is **strongly** recommended that the bearings be replaced **any** time the shaft and bearings are removed.

Be sure the oil return groove on the inside bottom of the bearing cover is clean and free of dirt.

Inspect the shaft for distortion, nicks or scratches, or for thread damage on the impeller end. Dress small nicks and burrs with a fine file or emery cloth. Replace the shaft if defective.

The bearings may be heated to ease installation. An induction heater, hot oil bath, electric oven, or hot plate may be used to heat the bearings. Bearings should **never** be heated with a direct flame or directly on a hot plate.

NOTE

*If a hot oil bath is used to heat the bearings, both the oil and the container must be **absolutely** clean. If the oil has been previously used, it must be **thor-***

oughly filtered.

Heat the bearings to a uniform temperature **no higher than** 250°F (120°C), and slide the bearings onto the shaft, one at a time, until they are fully seated. This should be done quickly, in one continuous motion, to prevent the bearings from cooling and sticking on the shaft.



Use caution when handling hot bearings to prevent burns.

Slide the inboard bearing (51) onto the shaft until fully seated against the shaft shoulder.

Position the outboard bearing (44) on the shaft with the loading groove facing **away** from the impeller, and slide it onto the shaft until fully seated against the shaft shoulder.

After the bearings have been installed and allowed to cool, check to ensure that they have not moved away from the shaft shoulders in shrinking. If movement has occurred, use a suitably sized sleeve and a press to reposition the bearings against the shaft shoulders.

If heating the bearings is not practical, use a suitably sized sleeve and an arbor (or hydraulic) press to install the bearings on the shaft.



When installing the bearings onto the shaft, **never** press or hit against the outer race, balls, or ball cage. Press **only** on the inner race.

Slide the shaft and assembled bearings into the pedestal until the inboard bearing is fully seated against the bore shoulder.



When installing the shaft and bearings into the pedestal bore, push against the outer race. **Never** hit the balls or ball cage.

Slide the oil seal (23) over the shaft and press it into the pedestal bore with the lip positioned as shown in Figure E–1. **Be careful** not to damage the oil seal lip.

Install the oil seal (41) into the bearing cover (46) with the lip positioned as shown in Figure E–1.

Lubricate the bearing cover O-ring (47) and install it in the groove in the bearing cover.

Install the wavy washer (45) and position the bearing cover over the shaft and against the pedestal with the word “TOP” at the 12 o’clock position. Secure the bearing cover to the pedestal with the hardware (28 and 29).

Secure the pedestal to the base with the previously removed hardware. Be sure to reinstall any leveling shims used under the mounting feet.

Lubricate the bearings and pedestal as indicated in **LUBRICATION** at the end of this section.

Seal Reassembly and Installation

Clean the seal cavity and shaft with a cloth soaked in fresh cleaning solvent.



Most cleaning solvents are toxic and flammable. Use them only in a well ventilated area free from excessive heat, sparks, and flame. Read and follow all precautions printed on solvent containers.

Inspect the impeller shaft for damage. Small scratches or nicks may be removed with a fine file or emery cloth. If excessive wear exists, the shaft will have to be replaced.

The seal is not normally reused because wear patterns on the finished faces cannot be realigned during reassembly. This could result in premature failure. If necessary to reuse an old seal in an emergency, **carefully** wash all metallic parts in **fresh** cleaning solvent and allow to dry thoroughly.

Handle the seal parts with extreme care to prevent damage. Be careful not to contaminate precision finished faces; even fingerprints on the faces can shorten seal life. If necessary, clean the faces with a non-oil based solvent and a clean, lint-free tissue. Wipe **lightly** in a concentric pattern to avoid scratching the faces.

Inspect the seal components for wear, scoring, grooves, and other damage that might cause leakage. Clean and polish the shaft sleeve (30), or replace it if there are nicks or cuts on either end. If any components are worn, replace the complete seal; **never mix old and new seal parts.**

If a replacement seal is being used, remove it from the container and inspect the precision finished faces to ensure that they are free of any foreign matter.

To ease installation of the seal, lubricate the O-rings, bellows and shaft sleeve with water or a very **small** amount of oil, and apply a drop of light lubricating oil on the finished faces. Assemble the seal as follows, (see Figure E–2).

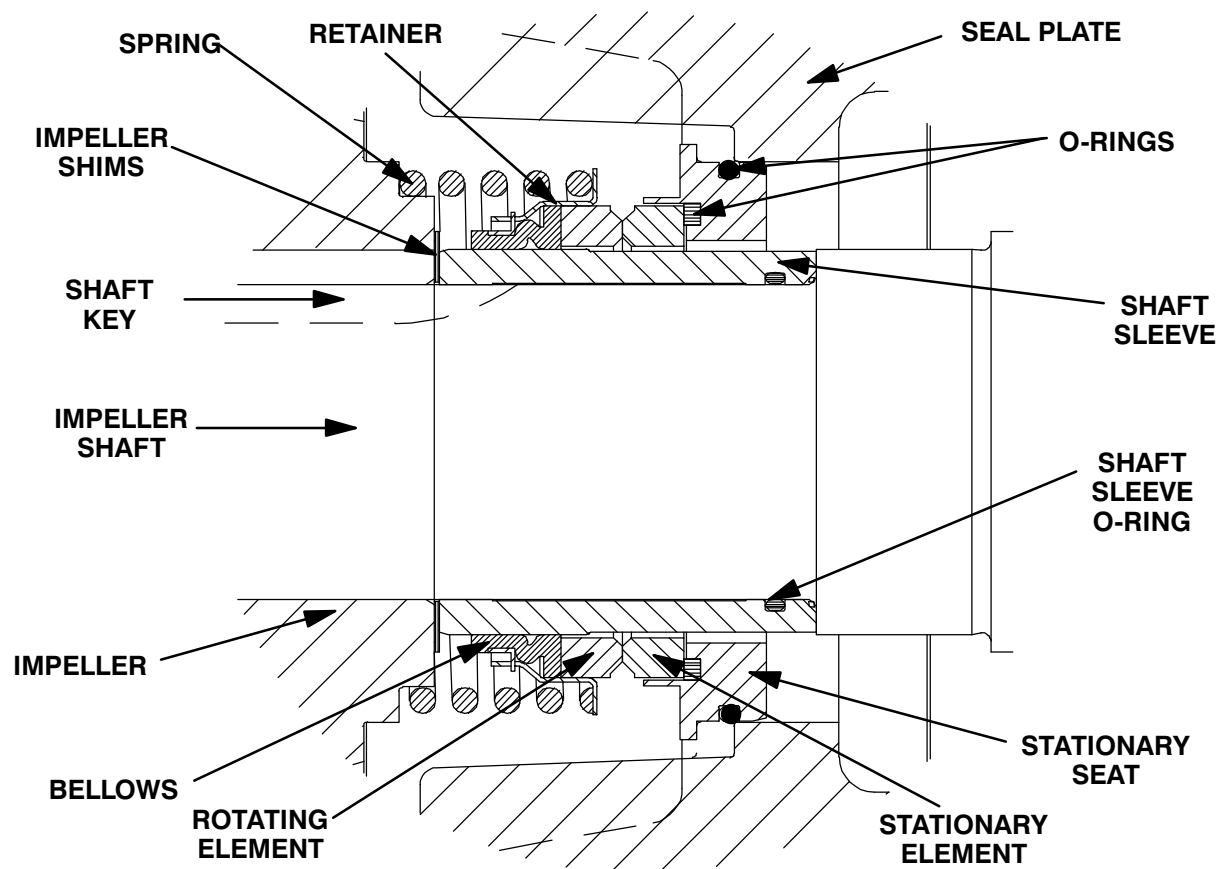

Figure E-2. 46512-259 Seal Assembly



This seal is not designed for operation at temperatures above 160°F (71°C). Do not use at higher operating temperatures.

Lubricate the O-rings (22 and 52) with a small amount of grease and install them on the seal plate (55).

Position the seal plate on a flat surface with the impeller side up. Press the stationary subassembly (consisting of the stationary seat, O-rings and stationary element) into the seal plate until the stationary seat bottoms against the seal plate bore.

Slide the seal plate onto the shaft and secure it to the pedestal with the hardware (24 and 25).

Lubricate and install the O-ring in the groove in the I.D. of the shaft sleeve (30). Lubricate the shaft sleeve and slide the rotating subassembly (consisting of the rotating element, retainer and bellows) onto the sleeve until the rotating element is

just flush with the chamfered end of the shaft. Slide the sleeve and rotating subassembly onto the shaft until the seal faces contact. **Use caution** to ensure that the shaft sleeve O-ring is not cut or damaged on the impeller keyway. Continue to push the sleeve through the seal until it bottoms against the shaft shoulder. Install the seal spring.

Lubricate the seal assembly as indicated in **LUBRICATION**, after the impeller has been installed.

Impeller Installation And Adjustment

Inspect the impeller, and replace it if cracked or badly worn. Install the same thickness of impeller adjusting shims as previously removed, and install the impeller key (80). Apply a thin, uniform coat of "Never-Seez" or equivalent compound to the shaft area under the impeller and press the impeller onto the shaft until fully seated. Make sure the seal spring is squarely seated over the step on the back of the impeller.

A clearance of .010 to .020 inch (0,25 to 0,51 mm) is required between the impeller and seal plate to

achieve maximum pump efficiency. Use a feeler gauge to measure this clearance and add or remove impeller adjusting shims as required.

NOTE

If the pump casing (1) has been secured to the pedestal assembly, this clearance may be obtained by removing shims until the impeller scrapes against the seal plate when the shaft is turned by hand. After the impeller scrapes, add approximately .010 inch (0,25 mm) of shims and reinstall the impeller. Check to ensure there is no scraping or binding before proceeding with pump reassembly.

Make sure the threads on the impeller capscrew (77) and the tapped threads in the impeller shaft are clean (degreased). Install the roll pin and impeller washer (78 and 79). Apply four drops of “Loctite Threadlocker No. 242-31” or equivalent around the circumference of the capscrew threads, one inch from the end of the capscrew. Install the capscrew and torque to 145 ft. lbs. or 1740 in. lbs. (20 m. kg.).

Pump Casing Installation

Ensure that the seal plate O-ring (22) is installed and lubricated with light grease or a very **small** amount of oil. Secure the pump casing and bottle oiler bracket (38) to the pedestal assembly with the hardware (37, 53 and 54).

Reinstall the bottle oiler (39). Remove the plug from the hose (35), reconnect it to the male connector (34) in the seal plate and secure with the clamp (36).

If removed, replace the discharge flange gasket (20) and secure the reducer (18) with the hardware (15, 16 and 17). Reconnect the discharge piping.

Wear Plate And Suction Elbow Installation

Lubricate the wear plate O-ring (65) with “Never-Seez” or equivalent and install it in the groove in the wear plate (66). Press the wear plate into the suction elbow (69) and secure it with the hardware (63 and 64).

Lubricate the wear plate O-ring (57) with “Never-Seez” or equivalent and install it in the groove on the wear plate. Secure the suction elbow and wear plate to the pump casing with the hardware (12, 13, 60 and 61).

A clearance of .010 to .020 inch (0,25 to 0,51 mm) between the impeller and the wear plate is also recommended for maximum pump efficiency. To adjust this clearance, back off the jam nuts (11) until they contact the heads of the wear plate adjusting screws (10). Loosen the hardware (63 and 64) securing the wear plate to the suction elbow. Tighten the adjusting screws evenly, no more than a half turn at a time, while rotating the impeller shaft by hand until the wear plate scrapes against the impeller. Back off each of the adjusting screws 1/2 turn, then tighten the jam nuts until they are snug against the suction head. Re-tighten the hardware (63 and 64).

Secure the pedestal foot (58) and suction elbow support (68) to the pump casing using the hardware (60, 61, 70 and 71). Reinstall any leveling shims used under the pedestal foot and suction elbow support, and secure them to the base with the previously removed hardware.

Suction Check Valve Installation

Install one stainless steel flat washer (86) on each side of the bearing pivot arm. Position the check valve (90) in the check valve body (88) with the 1/2” diameter core holes toward the pump side of the check valve body. Secure the check valve and pivot caps (87) to the check valve body with the hardware (84 and 89).

NOTE

Be sure the check valve is positioned so that the 1/2” diameter core holes face toward the interior of the pump.

Secure the check valve body to the suction elbow with the “Victaulic” coupling (4). Be sure the rubber gasket is properly seated and not damaged.

Reach through the cover plate access opening and check the operation of the check valve to ensure proper seating and free movement.

Final Pump Assembly

Install the shaft key (42) and reconnect the pump to the power source. **Be sure** the pump and power source are properly aligned, (see **Alignment in INSTALLATION**) before installing the leveling shims and base mounting hardware.

Fill the pump casing with clean liquid. Reinstall the cover plate assembly (5) and gasket (6) and tighten it.

Be sure the pump and power source are securely mounted to the base and that they are properly aligned. If used, removed the eye bolt used to lift component parts.

Install the suction and discharge lines and open all valves. Make certain that all piping connections are tight, properly supported and secure. Open all the valves in the suction and discharge lines.

Be sure the pump and power source have been properly lubricated, see **LUBRICATION**.

Refer to **OPERATION**, Section C, before putting the pump back into service.

PRESSURE RELIEF VALVE MAINTENANCE

The suction elbow is equipped with a pressure relief valve (81) to provide additional safety for the pump and operator (refer to **Liquid Temperature And Overheating in OPERATION**).

It is recommended that the pressure relief valve assembly be replaced at each overhaul, or any time the pump overheats and activates the valve. **Never** replace this valve with a substitute which has not been specified or provided by the Gorman-Rupp Company.

Periodically, the valve should be removed for inspection and cleaning. When reinstalling the relief valve, apply 'Loctite Pipe Sealant With Teflon No. 592' or equivalent compound, on the relief valve threads. Position the valve air vent with the discharge port pointing down.

LUBRICATION

Bearings

The pedestal was fully lubricated when shipped from the factory. Check the oil level regularly and maintain it at the midpoint of the sight gauge (48). When lubrication is required, unscrew the air vent (27) and fill the pedestal with SAE No. 30 non-detergent oil. Clean and reinstall the pedestal air vent.

When lubricating a dry (overhauled) pedestal, add approximately 128 ounces (3,8 Liters) of oil. **Do not** overfill. Over-lubrication can cause the bearings to over-heat, resulting in premature bearing failure.

Under normal conditions, change the oil each 5000 hours of operation, or at twelve month intervals, which ever occurs first. Change the oil more frequently if the pump is operated continuously or installed in an environment with rapid temperature change.

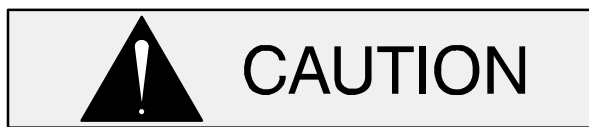

Monitor the condition of the bearing lubricant regularly for evidence of rust or moisture condensation. This is especially important in areas where variable hot and cold temperatures are common.

For cold weather operation, consult the factory or a lubricant supplier for the recommended grade of oil.

Seal Assembly

Check the seal lubricant before starting the pump and periodically during operation. Fill the bottle oiler with SAE No. 30 non-detergent oil. Check the oil level regularly and maintain it at the level indicated on the bottle oiler.

Periodically clean and reinstall the seal cavity air vent (26).

Power Source

Consult the literature supplied with the power source, or contact your local power source representative.

**For U.S. and International Warranty Information,
Please Visit www.grpumps.com/warranty
or call:
U.S.: 419-755-1280
International: +1-419-755-1352**

**For Canadian Warranty Information,
Please Visit www.grcanada.com/warranty
or call:
519-631-2870**