

**INSTALLATION, OPERATION,
AND MAINTENANCE MANUAL**
WITH PARTS LIST



80 SERIES PUMP

MODEL
81 1/2D3-E.50 1P

THE GORMAN-RUPP COMPANY • MANSFIELD, OHIO

www.grpumps.com

GORMAN-RUPP OF CANADA LIMITED • ST. THOMAS, ONTARIO, CANADA

Printed in U.S.A.

©1979 The Gorman-Rupp Company

Register your new
Gorman-Rupp pump online at
www.grpumps.com

Valid serial number and e-mail address required.

RECORD YOUR PUMP MODEL AND SERIAL NUMBER

Please record your pump model and serial number in the spaces provided below. Your Gorman-Rupp distributor needs this information when you require parts or service.

Pump Model: _____

Serial Number: _____

TABLE OF CONTENTS

INTRODUCTION	PAGE I – 1
SAFETY - SECTION A	PAGE A – 1
INSTALLATION – SECTION B	PAGE B – 1
Pump Dimensions	PAGE B – 1
PREINSTALLATION INSPECTION	PAGE B – 1
POSITIONING PUMP	PAGE B – 2
Lifting	PAGE B – 2
Mounting	PAGE B – 2
SUCTION AND DISCHARGE PIPING	PAGE B – 2
Materials	PAGE B – 2
Line Configuration	PAGE B – 2
Connections to Pump	PAGE B – 3
Gauges	PAGE B – 3
SUCTION LINES	PAGE B – 3
Fittings	PAGE B – 3
Strainers	PAGE B – 3
Sealing	PAGE B – 3
Suction Lines In Sumps	PAGE B – 3
Suction Line Positioning	PAGE B – 4
DISCHARGE LINES	PAGE B – 4
Siphoning	PAGE B – 4
Valves	PAGE B – 4
Bypass Lines	PAGE B – 5
ELECTRICAL CONNECTIONS	PAGE B – 5
OPERATION – SECTION C	PAGE C – 1
PRIMING	PAGE C – 1
STARTING	PAGE C – 1
Rotation	PAGE C – 1
OPERATION	PAGE C – 2
Lines With a Bypass	PAGE C – 2
Lines Without a Bypass	PAGE C – 2
Leakage	PAGE C – 2
Liquid Temperature And Overheating	PAGE C – 2
Strainer Check	PAGE C – 2
Pump Vacuum Check	PAGE C – 2
STOPPING	PAGE C – 3
Cold Weather Preservation	PAGE C – 3
TROUBLESHOOTING – SECTION D	PAGE D – 1
PREVENTIVE MAINTENANCE	PAGE D – 3
PUMP MAINTENANCE AND REPAIR - SECTION E	PAGE E – 1
STANDARD PERFORMANCE CURVE	PAGE E – 1

TABLE OF CONTENTS
(continued)

PARTS LIST:	
Pump Model	PAGE E – 3
PUMP AND SEAL DISASSEMBLY AND REASSEMBLY	PAGE E – 4
Suction Flap Valve Removal and Disassembly	PAGE E – 4
Impeller Removal	PAGE E – 4
Seal Removal	PAGE E – 5
Seal Reassembly and Installation	PAGE E – 5
Impeller Installation	PAGE E – 6
Suction Flap Valve Reassembly and Installation	PAGE E – 7
Final Pump Assembly	PAGE E – 7
LUBRICATION	PAGE E – 7
Seal Assembly	PAGE E – 7

INTRODUCTION

Thank You for purchasing a Gorman-Rupp pump. **Read this manual** carefully to learn how to safely install and operate your pump. Failure to do so could result in personal injury or damage to the pump.

This pump is an 80 Series, semi-open impeller, self-priming centrifugal model without a suction check valve. It is close-coupled to a 1/2 H.P., single phase, totally enclosed, fan-cooled electric motor. The basic material of construction for wetted parts is gray iron, with bronze impeller and stainless steel motor shaft. The pump is designed for handling most non-volatile, nonflammable liquids containing specified entrained solids.

For information or technical assistance on the motor, contact the motor manufacturer's local dealer or representative.

This manual will alert personnel to known procedures which require special attention, to those which could damage equipment, and to those which could be dangerous to personnel. However, this manual cannot possibly anticipate and provide detailed precautions for every situation that might occur during maintenance of the unit. Therefore, it is the responsibility of the owner/maintenance personnel to ensure that **only** safe, established maintenance procedures are used, and that any procedures not addressed in this manual are performed **only** after establishing that neither personal safety nor pump integrity are compromised by such practices.

If there are any questions regarding the pump or its application which are not covered in this manual or in other literature accompanying this unit, please contact your Gorman-Rupp distributor, or:

The Gorman-Rupp Company
P.O. Box 1217
Mansfield, Ohio 44901-1217
Phone: (419) 755-1011
 or:
Gorman-Rupp of Canada Limited
70 Burwell Road
St. Thomas, Ontario N5P 3R7
Phone: (519) 631-2870

The following are used to alert maintenance personnel to procedures which require special attention, to those which could damage equipment, and to those which could be dangerous to personnel:



Immediate hazards which WILL result in severe personal injury or death. These instructions describe the procedure required and the injury which will result from failure to follow the procedure.



Hazards or unsafe practices which COULD result in severe personal injury or death. These instructions describe the procedure required and the injury which could result from failure to follow the procedure.



Hazards or unsafe practices which COULD result in minor personal injury or product or property damage. These instructions describe the requirements and the possible damage which could result from failure to follow the procedure.

NOTE

Instructions to aid in installation, operation, and maintenance or which clarify a procedure.

SAFETY - SECTION A

This information applies to 80 Series electric motor driven pumps. Refer to the manual accompanying the motor before attempting to begin operation.

Because pump installations are seldom identical, this manual cannot possibly provide detailed instructions and precautions for each specific application. Therefore, it is the owner/installer's responsibility to ensure that applications not addressed in this manual are performed only after establishing that neither operator safety nor pump integrity are compromised by the installation.



Before attempting to open or service the pump:

1. Familiarize yourself with this manual.
2. Unplug the motor power cable from the electrical outlet to ensure that the pump will remain inoperative.
3. Allow the pump to completely cool if overheated.
4. Check the temperature before opening any covers, plates, or plugs.
5. Close the suction and discharge valves.
6. Vent the pump slowly and cautiously.
7. Drain the pump.



This pump is designed to handle most non-volatile, non-flammable liquids

containing specified entrained solids. Do not attempt to pump volatile, corrosive, or flammable liquids which may damage the pump or endanger personnel as a result of pump failure.



After the pump has been installed, make certain that the pump and all piping or hose connections are tight, properly supported and secure before operation.



Do not operate the pump against a closed discharge valve for long periods of time. If operated against a closed discharge valve, pump components will deteriorate, and the liquid could come to a boil, build pressure, and cause the pump casing to rupture or explode.



Do not remove plates, covers, gauges, pipe plugs, or fittings from an overheated pump. Vapor pressure within the pump can cause parts being disengaged to be ejected with great force. Allow the pump to cool before servicing.



Do not install and operate a non-explosion proof motor in an explosive atmosphere. Install, connect, and operate the motor in accordance with the National Electric Code and all local codes. If there is a conflict between the instructions in the manual accompanying the unit and the National Electric Code or

the applicable local code, the National or local code shall take precedence.



The electrical power used to operate this pump is high enough to cause injury or death. Obtain the services of a qualified electrician to troubleshoot, test and/or service the electrical components of this pump.



Never run this pump backwards. Be certain that rotation is correct before fully engaging the pump.

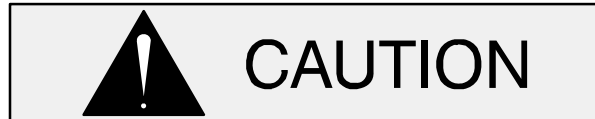

Pumps and related equipment must be installed and operated according to all national, local and industry standards.

INSTALLATION – SECTION B

Review all SAFETY information in Section A.

Since pump installations are seldom identical, this section offers only general recommendations and practices required to inspect, position, and arrange the pump and piping.

Most of the information pertains to a standard **static lift** application where the pump is positioned above the free level of liquid to be pumped.

If installed in a **flooded suction application** where the liquid is supplied to the pump under pressure, some of the information such as mounting, line configuration, and priming must be tailored to the

specific application. Since the pressure supplied to the pump is critical to performance and safety, **be sure** to limit the incoming pressure to 50% of the maximum permissible operating pressure as shown on the pump performance curve (see Section E, Page 1).

For further assistance, contact your Gorman-Rupp distributor or the Gorman-Rupp Company.

Pump Dimensions

See Figure 1 for the approximate physical dimensions of this pump.

OUTLINE DRAWING

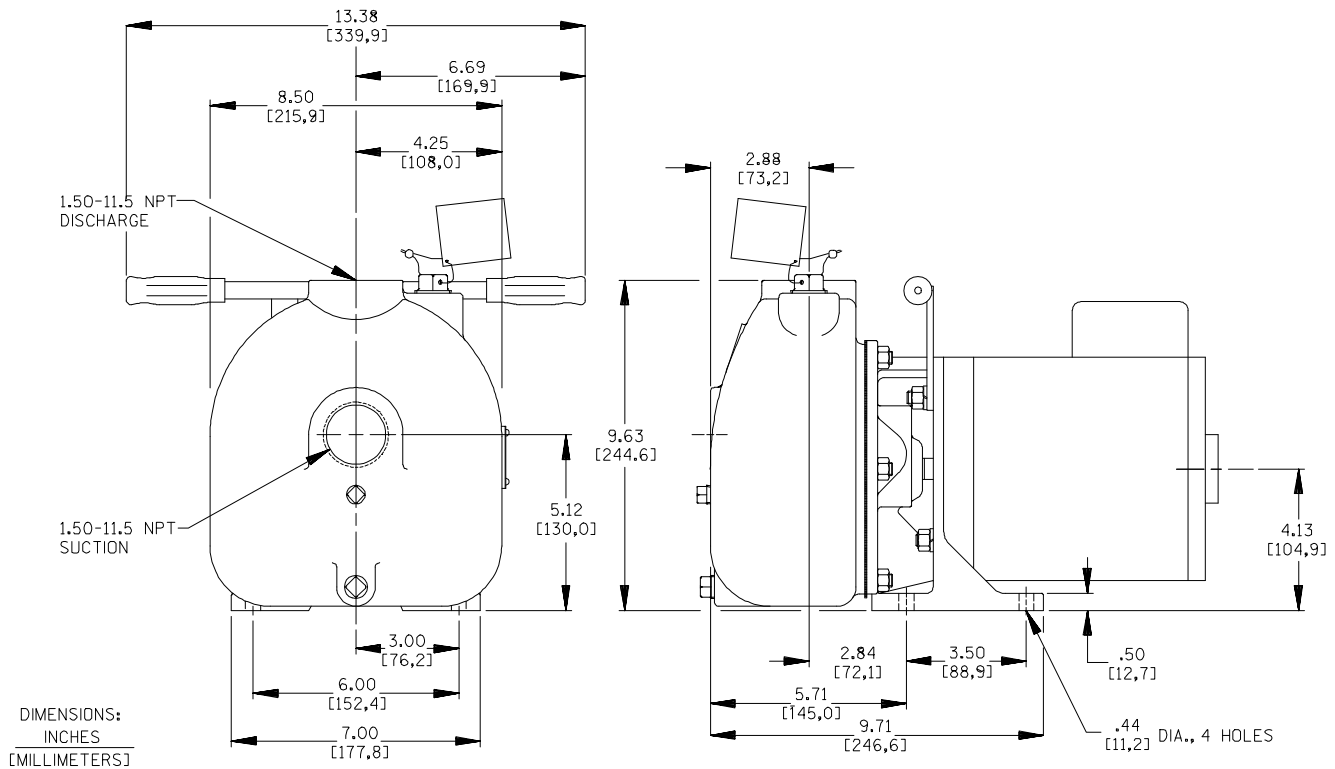

Figure 1. Pump Model 81 1/2D3-E.50 1P

PREINSTALLATION INSPECTION

The pump assembly was inspected and tested before shipment from the factory. Before installation, inspect the pump for damage which may have occurred during shipment. Check as follows:

- a. Inspect the pump and motor for cracks, dents, damaged threads, and other obvious damage.
- b. Check for and tighten loose attaching hardware. Since gaskets tend to shrink after dry-

ing, check for loose hardware at mating surfaces.

- c. Carefully read all tags, decals, and markings on the pump assembly, and perform all duties indicated. Note that the pump shaft rotates in the required direction.



The impeller of the pump is threaded onto the pump shaft. Reverse rotation of the shaft can cause the impeller to unscrew and break the suction head or casing. Disconnect the power before checking for proper direction of rotation.

- d. Check levels and lubricate as necessary. Refer to **LUBRICATION** in the **MAINTENANCE AND REPAIR** section of this manual and perform duties as instructed.
- e. If the pump and motor have been stored for more than 12 months, some of the components or lubricants may have exceeded their maximum shelf life. These **must be inspected or replaced** to ensure maximum pump service.



The electrical power used to operate this pump is high enough to cause injury or death. Obtain the services of a qualified electrician to troubleshoot, test and/or service the electrical components of this pump.

If the maximum shelf life has been exceeded, or if anything appears to be abnormal, contact your Gorman-Rupp distributor or the factory to determine the repair or updating policy. **Do not** put the pump into service until appropriate action has been taken.

POSITIONING PUMP

Lifting

Pump unit weights will vary depending on the mounting and drive provided. Check the shipping tag on the unit packaging for the actual weight, and use lifting equipment with appropriate capacity. Drain the pump and remove all customer-installed equipment such as suction and discharge hoses or piping before attempting to lift existing, installed units.



The pump assembly can be seriously damaged if the chains or cables used to lift and move the unit are improperly wrapped around the pump.

Mounting

Locate the pump in an accessible place as close as practical to the liquid being pumped. Level mounting is essential for proper operation.

The pump may have to be supported or shimmed to provide for level operation or to eliminate vibration.

SUCTION AND DISCHARGE PIPING

Pump performance is adversely effected by increased suction lift, discharge elevation, and friction losses. See the performance curve on Page E-1 to be sure your overall application allows pump to operate within the safe operation range.

Materials

Either pipe or hose maybe used for suction and discharge lines; however, the materials must be compatible with the liquid being pumped. If hose is used in suction lines, it must be the rigid-wall, reinforced type to prevent collapse under suction. Using piping couplings in suction lines is not recommended.

Line Configuration

Keep suction and discharge lines as straight as possible to minimize friction losses. Make mini-

mum use of elbows and fittings, which substantially increase friction loss. If elbows are necessary, use the long-radius type to minimize friction loss.

Connections to Pump

Before tightening a connecting flange, align it exactly with the pump port. Never pull a pipe line into place by tightening the flange bolts and/or couplings.

Lines near the pump must be independently supported to avoid strain on the pump which could cause excessive vibration, decreased bearing life, and increased shaft and seal wear. If hose-type lines are used, they should have adequate support to secure them when filled with liquid and under pressure.

Gauges

Most pumps are drilled and tapped for installing discharge pressure and vacuum suction gauges. If these gauges are desired for pumps that are not tapped, drill and tap the suction and discharge lines not less than 18 inches (457,2 mm) from the suction and discharge ports and install the lines. Installation closer to the pump may result in erratic readings.

SUCTION LINES

To avoid air pockets which could affect pump priming, the suction line must be as short and direct as possible. When operation involves a suction lift, the line must always slope upward to the pump from the source of the liquid being pumped; if the line slopes down to the pump at any point along the suction run, air pockets will be created.

Fittings

Suction lines should be the same size as the pump inlet. If reducers are used in suction lines, they should be the eccentric type, and should be installed with the flat part of the reducers uppermost to avoid creating air pockets. Valves are not normally used in suction lines, but if a valve is used, install it with the stem horizontal to avoid air pockets.

Strainers

If a strainer is furnished with the pump, be certain to use it; any spherical solids which pass through a strainer furnished with the pump will also pass through the pump itself.

If a strainer is not furnished with the pump, but is installed by the pump user, make certain that the total area of the openings in the strainer is at least three or four times the cross section of the suction line, and that the openings will not permit passage of solids larger than the solids handling capability of the pump.

This pump is designed to handle up to 1/4 inch (6,4 mm) diameter spherical solids.

Sealing

Since even a slight leak will affect priming, head, and capacity, especially when operating with a high suction lift, all connections in the suction line should be sealed with pipe dope to ensure an airtight seal. Follow the sealant manufacturer's recommendations when selecting and applying the pipe dope. The pipe dope should be compatible with the liquid being pumped.

Suction Lines In Sumps

If a single suction line is installed in a sump, it should be positioned away from the wall of the sump at a distance equal to 1-1/2 times the diameter of the suction line

If there is a liquid flow from an open pipe into the sump, the flow should be kept away from the suction inlet because the inflow will carry air down into the sump, and air entering the suction line will reduce pump efficiency.

If it is necessary to position inflow close to the suction inlet, install a baffle between the inflow and the suction inlet at a distance 1-1/2 times the diameter of the suction pipe. The baffle will allow entrained air to escape from the liquid before it is drawn into the suction inlet.

If two suction lines are installed in a single sump, the flow paths may interact, reducing the efficiency of one or both pumps. To avoid this, position the suction inlets so that they are separated by a dis-

tance equal to at least 3 times the diameter of the suction pipe.

Suction Line Positioning

The depth of submergence of the suction line is critical to efficient pump operation. Figure 2 shows recommended minimum submergence vs. velocity.

NOTE

The pipe submergence required may be reduced by installing a standard pipe increaser fitting at the end of the suction line. The larger opening size will reduce the inlet velocity. Calculate the required submergence using the following formula based on the increased opening size (area or diameter).

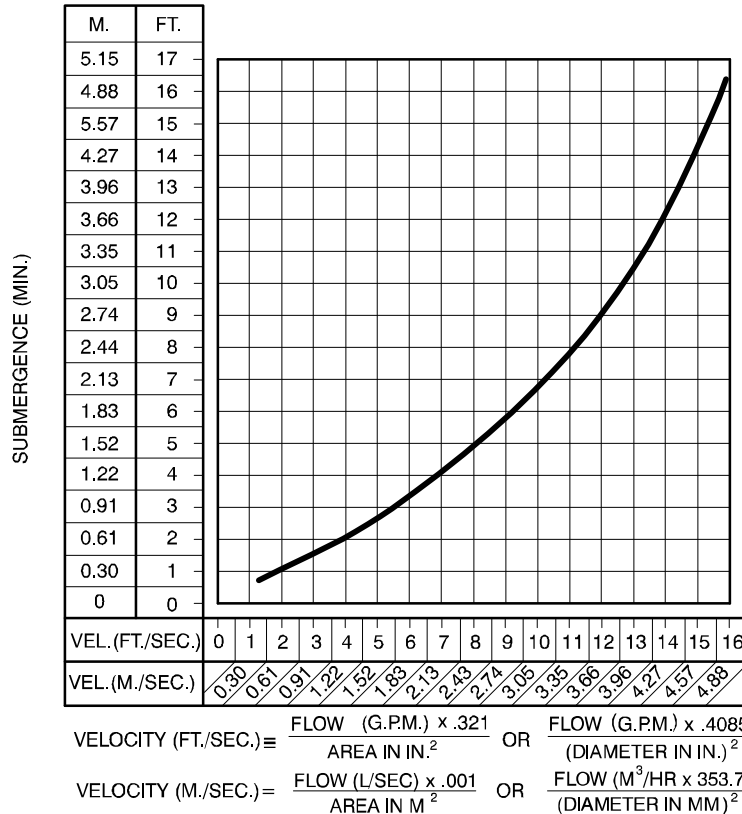

Figure 2. Recommended Minimum Suction Line Submergence vs. Velocity

DISCHARGE LINES

Siphoning

Do not terminate the discharge line at a level lower than that of the liquid being pumped unless a siphon breaker is used in the line. Otherwise, a siphoning action causing damage to the pump could result.

Valves

If a throttling valve is desired in the discharge line, use a valve as large as the largest pipe to minimize friction losses. Never install a throttling valve in a suction line.

A check valve in the discharge line is normally recommended, but it is not necessary in low discharge head applications.

With high discharge heads, it is recommended that a throttling valve and a system check valve be installed in the discharge line to protect the pump from excessive shock pressure and reverse rotation when it is stopped.



If the application involves a high discharge head, gradually close the discharge throttling valve before stopping the pump.

Bypass Lines

If a system check valve is used due to high discharge head, it may be necessary to vent trapped air from the top of the pump during the priming process. This may be accomplished by installing a bypass line from the top of the pump, back to the source of liquid. The end of the bypass line must be submerged. The line must be large enough to prevent clogging, but not so large as to affect pump discharge capacity.

ELECTRICAL CONNECTIONS

Before connecting the motor to the incoming power, check that the electrical service available matches the pump motor requirements stamped on the motor nameplate.



The electrical power used to operate

this pump is high enough to cause injury or death. Obtain the services of a qualified electrician to make all electrical connections.



Do not install and operate a non-explosion proof motor in an explosive atmosphere. Install, connect, and operate the motor in accordance with The National Electric Code and all local codes. If there is a conflict between the instructions in the manual accompanying the unit and The National Electric Code or the applicable local code, The National or local code shall take precedence.

Refer to the following motor data before making electrical connections.

MODEL	VOLTAGE	PHASE	HP	Hz	RPM	FRAME
81 1/2D3-E.50 1P	115/230	1	.50	60	3450	56J

OPERATION – SECTION C

Review all **SAFETY** information in Section A.

Follow the instructions on all tags, labels and decals attached to the pump.



This pump is designed to handle most non-volatile, non-flammable liquids containing specified entrained solids. Do not attempt to pump volatile, corrosive, or flammable liquids which may damage the pump or endanger personnel as a result of pump failure.



Pump speed and operating condition points must be within the continuous performance range shown on the curve (see Section E, Page 1).

PRIMING

Install the pump and piping as described in **INSTALLATION**. Make sure that the piping connections are tight, and that the pump is securely mounted. Check that the pump is properly lubricated (see **LUBRICATION** in **MAINTENANCE AND REPAIR**).

This pump is self-priming, but the pump should never be operated unless there is liquid in the pump casing.



Never operate this pump unless there is liquid in the pump casing. The pump will not prime when dry. Extended operation of a dry pump will destroy the seal assembly.

Add liquid to the pump casing when:

1. The pump is being put into service for the first time.
2. The pump has not been used for a considerable length of time.
3. The liquid in the pump casing has evaporated.

Once the pump casing has been filled, the pump will prime and reprime as necessary.



After filling the pump casing, reinstall and tighten the fill plug. Do not attempt to operate the pump unless all connecting piping is securely installed. Otherwise, liquid in the pump forced out under pressure could cause injury to personnel.

To fill the pump, remove the pump casing fill cover or fill plug in the top of the casing, and add clean liquid until the casing is filled. Replace the fill cover or fill plug before operating the pump.

STARTING

Consult the operations manual furnished with the motor.

OPERATION

Lines With a Bypass

Close the discharge throttling valve (if so equipped) so that the pump will not have to prime against the weight of the liquid in the discharge line. Air from the suction line will be discharged through the bypass line back to the wet well during the priming cycle. When the pump is fully primed and liquid is flowing steadily from the bypass line, open the discharge throttling valve. Liquid will then continue to circulate through the bypass line while the pump is in operation.

Lines Without a Bypass

Open all valves in the discharge line and start the motor. Priming is indicated by a positive reading on the discharge pressure gauge or by a quieter operation. The pump may not prime immediately because the suction line must first fill with liquid. If the pump fails to prime within five minutes, stop it and check the suction line for leaks.

After the pump has been primed, partially close the discharge line throttling valve in order to fill the line slowly and guard against excessive shock pressure which could damage pipe ends, gaskets, sprinkler heads, and any other fixtures connected to the line. When the discharge line is completely filled, adjust the throttling valve to the required flow rate.

Leakage

No leakage should be visible at pump mating surfaces, or at pump connections or fittings. Keep all line connections and fittings tight to maintain maximum pump efficiency.

Liquid Temperature And Overheating

The **maximum** liquid temperature for this pump is 160° F (71°C). Do not apply it at a higher operating temperature.

Overheating can occur if operated with the valves in the suction or discharge lines closed. Operating against closed valves could bring the liquid to a boil, build pressure, and cause the pump to rupture or explode. If overheating occurs, stop the pump and allow it to cool before servicing it. Refill the pump casing with cool liquid.



Do not remove plates, covers, gauges, pipe plugs, or fittings from an overheated pump. Vapor pressure within the pump can cause parts being disengaged to be ejected with great force. Allow the pump to cool before servicing.

Strainer Check

If a suction strainer has been shipped with the pump or installed by the user, check the strainer regularly, and clean it as necessary. The strainer should also be checked if pump flow rate begins to drop. If a vacuum suction gauge has been installed, monitor and record the readings regularly to detect strainer blockage.

Never introduce air or steam pressure into the pump casing or piping to remove a blockage. This could result in personal injury or damage to the equipment. If backflushing is absolutely necessary, **liquid pressure** must be limited to 50% of the maximum permissible operating pressure shown on the pump performance curve (see Section E, Page 1).

Pump Vacuum Check

With the pump inoperative, install a vacuum gauge in the system, using pipe dope on the threads. Block the suction line and start the pump. At operating speed the pump should pull a vacuum of 20 inches (508 mm) or more of mercury. If it does not, check for air leaks in the seal, gasket, or discharge valve.

Open the suction line, and read the vacuum gauge with the pump primed and at operation speed. Shut off the pump. The vacuum gauge reading will immediately drop proportionate to static suction lift, and should then stabilize. If the vacuum reading falls off rapidly after stabilization, an air leak exists. Before checking for the source of the leak, check the point of installation of the vacuum gauge.

STOPPING

Never halt the flow of liquid suddenly. If the liquid being pumped is stopped abruptly, damaging shock waves can be transmitted to the pump and piping system. Close all connecting valves slowly.



If the application involves a high discharge head, gradually close the discharge throttling valve before stopping the pump.

After stopping the pump, disconnect the incoming power to the motor and lock it out to ensure that the pump will remain inoperative.

Cold Weather Preservation

In below freezing conditions, drain the pump to prevent damage from freezing. Also, clean out any solids by flushing with a hose. Operate the pump for approximately one minute; this will remove any

remaining liquid that could freeze the pump rotating parts. If the pump will be idle for more than a few hours, or if it has been pumping liquids containing a large amount of solids, drain the pump, and flush it thoroughly with clean water. To prevent large solids from clogging the drain port and preventing the pump from completely draining, insert a rod or stiff wire in the drain port, and agitate the liquid during the draining process. Clean out any remaining solids by flushing with a hose.

TROUBLESHOOTING – SECTION D

Review all SAFETY information in Section A.



Before attempting to open or service the pump:

- 1. Familiarize yourself with this manual.**
- 2. Unplug the motor power cable from the electrical outlet to ensure that the pump will remain inoperative.**
- 3. Allow the pump to completely cool if overheated.**
- 4. Check the temperature before opening any covers, plates, or plugs.**
- 5. Close the suction and discharge valves.**
- 6. Vent the pump slowly and cautiously.**
- 7. Drain the pump.**

TROUBLE	POSSIBLE CAUSE	PROBABLE REMEDY
PUMP FAILS TO PRIME	Not enough liquid in casing. Suction check valve contaminated or damaged. Air leak in suction line. Lining of suction hose collapsed. Leaking or worn seal or pump gasket. Suction lift or discharge head too high. Strainer clogged.	Add liquid to casing. See PRIMING . Clean or replace check valve. Correct leak. Replace suction hose. Check pump vacuum. Replace leaking or worn seal or gasket. Check piping installation and install bypass line if needed. See INSTALLATION . Check strainer and clean if necessary.
PUMP STOPS OR FAILS TO DELIVER RATED FLOW OR PRESSURE	Air leak in suction line. Lining of suction hose collapsed. Suction intake not submerged at proper level or sump too small. Impeller or other wearing parts worn or damaged.	Correct leak. Replace suction hose. Check installation and correct submergence as needed. Replace worn or damaged parts. Check that impeller is properly centered and rotates freely.

TROUBLE	POSSIBLE CAUSE	PROBABLE REMEDY
PUMP STOPS OR FAILS TO DELIVER RATED FLOW OR PRESSURE (cont.)	<p>Leaking or worn seal or pump gasket.</p> <p>Impeller clogged.</p> <p>Low or incorrect voltage.</p> <p>No voltage at line side of circuit breaker.</p> <p>Suction lift or discharge head too high.</p>	<p>Check pump vacuum. Replace leaking or worn seal or gasket.</p> <p>Free impeller of debris.</p> <p>Measure control box voltage, both when pump is running and when shut off.</p> <p>Check power source for blown fuse, open circuit breaker or control box, broken lead, or loose connection.</p> <p>Check piping installation and install bypass line if needed. See INSTALLATION.</p>
PUMP REQUIRES TOO MUCH POWER	<p>Motor shaft or bearings defective.</p> <p>Discharge head too low.</p> <p>Liquid solution too thick.</p>	<p>Disassemble pump and check motor and bearings.</p> <p>Adjust discharge valve.</p> <p>Dilute if possible.</p>
PUMP CLOGS FREQUENTLY	<p>Discharge flow too slow.</p> <p>Suction check valve or foot valve clogged or binding.</p>	<p>Open discharge valve fully to increase flow rate, and run motor at maximum governed speed.</p> <p>Clean valve.</p>
EXCESSIVE NOISE	<p>Cavitation in pump.</p> <p>Pumping entrained air.</p> <p>Pump or drive not securely mounted.</p> <p>Impeller clogged or damaged.</p>	<p>Reduce suction lift and/or friction losses in suction line. Record vacuum and pressure gauge readings and consult local representative or factory.</p> <p>Locate and eliminate source of air bubble.</p> <p>Secure mounting hardware.</p> <p>Clean out debris; replace damaged parts.</p>

PREVENTIVE MAINTENANCE

Since pump applications are seldom identical, and pump wear is directly affected by such things as the abrasive qualities, pressure and temperature of the liquid being pumped, this section is intended only to provide general recommendations and practices for preventive maintenance. Regardless of the application however, following a routine preventive maintenance schedule will help assure trouble-free performance and long life from your Gorman-Rupp pump. For specific questions concerning your application, contact your Gorman-Rupp distributor or the Gorman-Rupp Company.

Record keeping is an essential component of a good preventive maintenance program. Changes in suction and discharge gauge readings (if so

equipped) between regularly scheduled inspections can indicate problems that can be corrected before system damage or catastrophic failure occurs. The appearance of wearing parts should also be documented at each inspection for comparison as well. Also, if records indicate that a certain part (such as the seal) fails at approximately the same duty cycle, the part can be checked and replaced before failure occurs, reducing unscheduled down time.

For new applications, a first inspection of wearing parts at 250 hours will give insight into the wear rate for your particular application. Subsequent inspections should be performed at the intervals shown on the chart below. Critical applications should be inspected more frequently.

Preventive Maintenance Schedule					
Item	Service Interval*				
	Daily	Weekly	Monthly	Semi-Annually	Annually
General Condition (Temperature, Unusual Noises or Vibrations, Cracks, Leaks, Loose Hardware, Etc.)	I				
Pump Performance (Gauges, Speed, Flow)	I				
Bearing Lubrication		I			R
Seal Lubrication (And Packing Adjustment, If So Equipped)		I			R
V-Belts (If So Equipped)			I		
Air Release Valve Plunger Rod (If So Equipped)			I	C	
Front Impeller Clearance (Wear Plate)				I	
Rear Impeller Clearance (Seal Plate)				I	
Check Valve					I
Pressure Relief Valve (If So Equipped)					C
Pump and Driver Alignment					I
Shaft Deflection					I
Bearings					I
Bearing Housing					I
Piping					I
Driver Lubrication – See Mfgr’s Literature					I

Legend:
 I = Inspect, Clean, Adjust, Repair or Replace as Necessary
 C = Clean
 R = Replace

* Service interval based on an intermittent duty cycle equal to approximately 4000 hours annually. Adjust schedule as required for lower or higher duty cycles or extreme operating conditions.

PUMP MAINTENANCE AND REPAIR - SECTION E

MAINTENANCE AND REPAIR OF THE WEARING PARTS OF THE PUMP WILL MAINTAIN PEAK OPERATING PERFORMANCE.

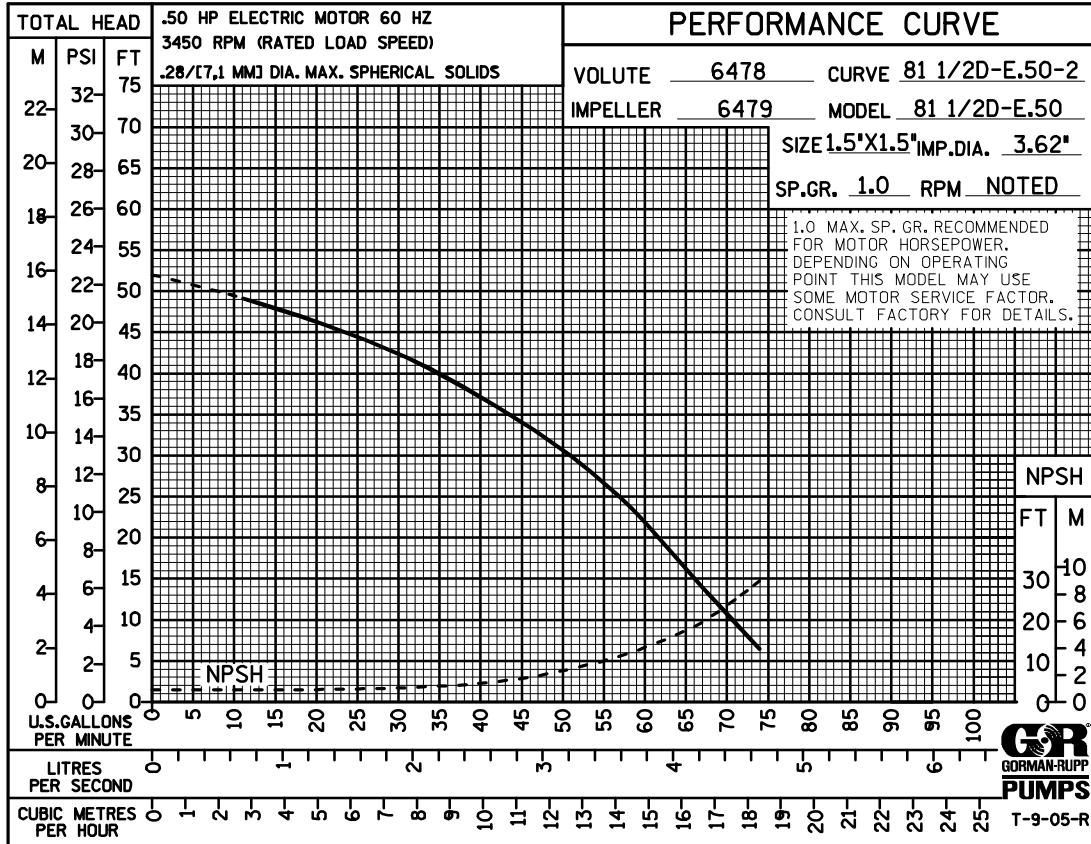

* STANDARD PERFORMANCE FOR PUMP MODEL 81 1/2D3-E.50 1P

* Based on 70° F (21° C) clear water at sea level with minimum suction lift. Since pump installations are seldom identical, your performance may be different due to such factors as viscosity, specific gravity, elevation, temperature, and impeller trim.

Contact the Gorman-Rupp Company to verify performance or part numbers.

If your pump serial number is followed by an "N", your pump is **NOT** a standard production model.



Pump speed and operating condition points must be within the continuous performance range shown on the curve.

SECTION DRAWING

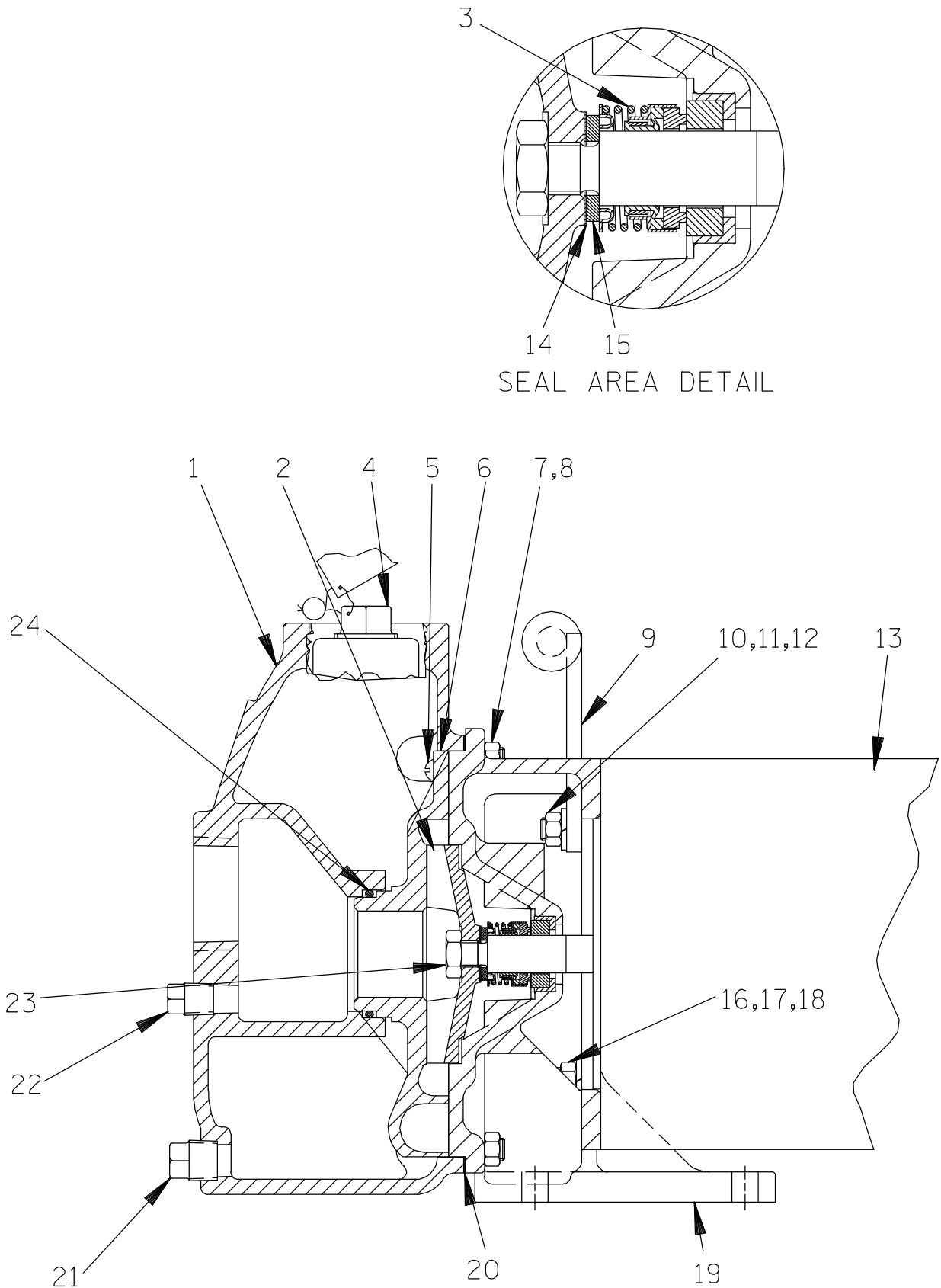

Figure 1. Pump Model 81 1/2D3-E.50 1P

PARTS LIST
Pump Model 81 1/2D3-E.50 1P
 (From S/N 262113 Up)

If your pump serial number is followed by an "N", your pump is **NOT** a standard production model. Contact the Gorman-Rupp Company to verify part numbers.

ITEM NO.	PART NAME	PART NUMBER	MAT'L CODE	QTY
1	PUMP CASING	6477	10010	1
2	* IMPELLER	6479	14010	1
3	* SEAL ASSEMBLY	25271-821	----	1
4	FILL PLUG ASSEMBLY	48271-061	----	1
5	ROUND HEAD MACHINE SCREW	X10-02	14990	2
6	VANE PLATE	6478	10010	1
7	STUD	C0605	15991	6
8	HEX NUT	D06	15991	6
9	HANDLE	44723-016	24150	1
10	STUD	C0606	15991	2
11	HEX NUT	D06	15991	2
12	LOCKWASHER	J06	15991	2
13	MOTOR, 1/2HP,1P	M03	----	1
14	* IMPELLER SHIM SET	5889	17000	1
15	* SEAL WASHER	6087	14110	1
16	STUD	C0605	15991	2
17	HEX NUT	D06	15991	2
18	LOCKWASHER	J06	15991	2
19	INTERMEDIATE	6103B	10010	2
20	* CASING GASKET	6103G	18000	1
21	CASING DRAIN PLUG	P06	11990	1
22	PIPE PLUG	P04	11990	1
23	* JAM NUT	AT07S	15991	1
24	* VANE PLATE O-RING	S300	----	1
NOT SHOWN:				
	NAMEPLATE	38812-041	13990	1
	DRIVE SCREW	BM#04-03	15990	4
	STRAINER	26841-007	----	1
	CORD ASSEMBLY	47365-007	----	1
	G-R DECAL	GR-03	----	1
	WARNING DECAL	2613FE	----	1
	WARNING DECAL	2613FF	----	1
	ROTATION DECAL	2613M	----	1
	INSTRUCTION TAG	38817-029	----	1
	SUCTION STICKER	6588AG	----	1
	FILL HERE TO PRIME STICKER	6588AH	----	1
	DISCHARGE STICKER	6588BJ	----	1
	ROTATION DECAL	2613M	----	1
OPTIONAL:				
	WHEEL KIT	GRP30-06A	----	1

* INDICATES PARTS RECOMMENDED FOR STOCK

PUMP AND SEAL DISASSEMBLY AND REASSEMBLY

Review all SAFETY information in Section A.

Follow the instructions on all tags, label and decals attached to the pump.

This pump requires little service due to its rugged, minimum-maintenance design. However, if it becomes necessary to inspect or replace the wearing parts, follow these instructions which are keyed to the sectional view (see Figure 1) and the accompanying parts list.

This manual will alert personnel to known procedures which require special attention, to those which could damage equipment, and to those which could be dangerous to personnel. However, this manual cannot possibly anticipate and provide detailed precautions for every situation that might occur during maintenance of the unit. Therefore, it is the responsibility of the owner/maintenance personnel to ensure that **only** safe, established maintenance procedures are used, and that any procedures not addressed in this manual are performed **only** after establishing that neither personal safety nor pump integrity are compromised by such practices.

Before attempting to service the pump, disconnect incoming power to the motor and lock it out to ensure that it will remain inoperative. Close all valves in the suction and discharge lines.

For motor disassembly and repair, consult the literature supplied with the motor, or contact your local motor representative.



Before attempting to open or service the pump:

- 1. Familiarize yourself with this manual.**
- 2. Unplug the motor power cable from the electrical outlet to ensure that the pump will remain inoperative.**
- 3. Allow the pump to completely cool if overheated.**

- 4. Check the temperature before opening any covers, plates, or plugs.**
- 5. Close the suction and discharge valves.**
- 6. Vent the pump slowly and cautiously.**
- 7. Drain the pump.**

Pump Casing and Vane Plate Removal

Before attempting to service the pump, remove the pump casing drain plug (21) and drain the pump. Clean and reinstall the drain plug.

To service the impeller (2), vane plate (6) or seal assembly (3), disconnect the suction and discharge piping.

Remove the nuts (9) securing the pump casing (1) to the intermediate (19). Remove the pump casing by pulling straight away.

Remove the casing gasket (20) and vane plate O-ring (24).

To remove the vane plate, disengage the screws (5).

Impeller Removal

Insert a large screwdriver in the slot in the end of the motor shaft to prevent shaft rotation. Remove the impeller jam nut (23). Use a soft-faced mallet to strike the impeller in a counterclockwise direction until the breaks loose, then unscrew it from the shaft.

Inspect the impeller and replace it if cracked or badly worn. Slide the impeller adjusting shims (15) off the impeller shaft. Tie and tag the shims, or measure and record their thickness for ease of reassembly.

Seal Removal

(Figures 1 and 2)

Remove the seal washer (15), spring centering washer and seal spring.

Apply oil to the seal area of the shaft and work it up under the rubber bellows. Remove the hardware

(11 and 12) securing the intermediate to the motor (13). Slide the intermediate and seal assembly off the shaft.

Position the intermediate on a flat surface with the impeller side down. Use a suitably sized dowel to press the seal stationary seat and element out of the intermediate from the back side.

Seal Reassembly and Installation

(Figures 1 and 2)

Clean the seal cavity and shaft with a cloth soaked in fresh cleaning solvent.



Most cleaning solvents are toxic and flammable. Use them only in a well-ventilated area free from excessive heat, sparks, and flame. Read and follow all precautions printed on solvent containers.

The seal is not normally reused because wear patterns on the finished faces cannot be realigned during reassembly. This could result in premature

failure. If necessary to reuse an old seal in an emergency, **carefully** wash all metallic parts in fresh cleaning solvent and allow to dry thoroughly.

Handle the seal parts with extreme care to prevent damage. Be careful not to contaminate precision finished faces; even fingerprints on the faces can shorten seal life. If necessary, clean the faces with a non-oil based solvent and a clean, lint-free tissue. Wipe **lightly** in a concentric pattern to avoid scratching the faces.

Inspect the seal components for wear, scoring, grooves, and other damage that might cause leakage. Clean and polish the seal area of the shaft. Small nicks and burrs can be removed using a fine file or emery cloth. If any components are worn, replace the complete seal; **never mix old and new seal parts.**

If a replacement seal is being used, remove it from the container and inspect the precision-finished faces to ensure that they are free of any foreign matter.

To ease installation of the seal, lubricate the seal area of the shaft with water or a very **small** amount of oil, and apply a drop of light lubricating oil on the finished faces. Assemble the seal as follows, (see Figure 2).

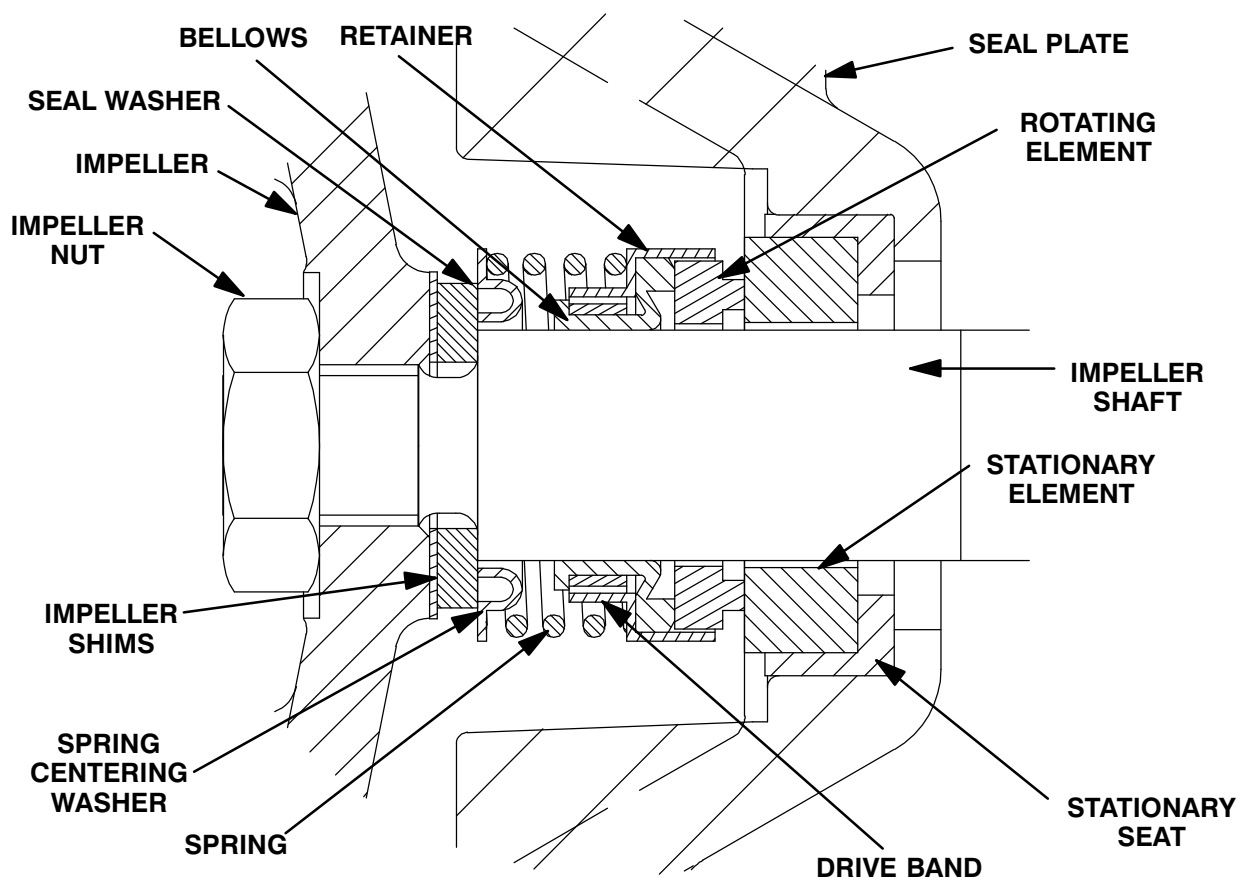
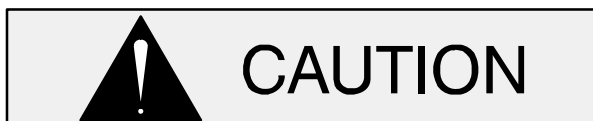

Figure 3. Seal Assembly



This seal is not designed for operation at temperatures above 160°F (71°C). Do not use at higher operating temperatures.

Install the stationary seat element in the stationary seat. Use your thumbs to press this subassembly into the seal bore in the intermediate until fully and squarely seated in the seal plate bore. After installation, wipe the stationary element sealing face lightly in a concentric pattern with a clean, lint-free cloth to remove any dirt or fingerprints.

Carefully slide the assembled intermediate and stationary portion of the seal over the impeller shaft and secure the intermediate to the motor with the hardware (11 and 12).

Slide the rotating portion of the seal assembly onto the shaft until the seal faces contact.

Install the seal spring, spring centering washer and seal washer (15).

Impeller Installation

Inspect the impeller, and replace it if cracked or badly worn. Install the same thickness of impeller shims (14) as previously removed. Apply 'Loctite Retaining Compound No. 242' or equivalent compound on the shaft threads and screw the impeller onto the shaft until tight.

A clearance of .008 to .015 inch (0,30 to 0,38 mm) between the impeller and the vane plate (6) is necessary for maximum pump efficiency. Position the vane plate over the impeller and use a feeler gauge to measure this clearance. Add or remove impeller shims until the proper clearance is achieved.

Vane Plate and Pump Casing Installation

Clean all of the old adhesive from the back side of the vane plate and the front side of the intermediate. Apply '3-M Adhesive EC-847' or equivalent compound to the back of the vane plate and secure the vane plate to the intermediate with the screws (5). Check impeller-to-vane plate clearance as described in **Impeller Installation**.

Install the vane plate O-ring (24) and the pump casing gasket (20). Carefully slide the pump casing over the vane plate and secure it to the intermediate with the nuts (8).

Final Pump Assembly

Be sure the pump and motor are securely mounted to the base.

Install the suction and discharge lines and open all valves. Make certain that all piping connections are tight, properly supported and secure.

Fill the pump casing with clean liquid. Reinstall the fill plug (4) and tighten it.

Refer to **OPERATION**, Section C, before putting the pump back into service.

LUBRICATION

Seal Assembly

The seal assembly is lubricated by the medium being pumped. No additional lubrication is required.

**For U.S. and International Warranty Information,
Please Visit www.grpumps.com/warranty
or call:
U.S.: 419-755-1280
International: +1-419-755-1352**

**For Canadian Warranty Information,
Please Visit www.grcanada.com/warranty
or call:
519-631-2870**